

Introduction

This Manual is to be read in conjunction with Ethos Operation Manual (TVL273) It is important that you familiarise yourself with both manuals before commencing any work with the Ethos or the Ethos HCD system. Be aware that the lift panel will contain equipment that is supplied with potentially lethal voltages. Please make sure the panel is isolated before carrying out any installation work or modifications. Note:- The HCD Server Panel contains a UPS which will shutdown in 2 mins after loss of power, be aware of 240V a.c whilst the UPS is still running.

The TVC Ethos HCD System is a distributed field-bus network for interfacing calls to an Navigator Hall Call Dispatcher. The system is used in place of normal discrete wiring for car and landing calls. Each passenger enters a destination level prior to entering the car. The Ethos Navigator Server allocates passenger requests (calls) to individual cars. As each lift user is required to select a destination the Dispatcher receives a more complete picture of traffic demand than would be available on a conventional system and is able to make more intelligent allocations.

Typical Wiring to DIP

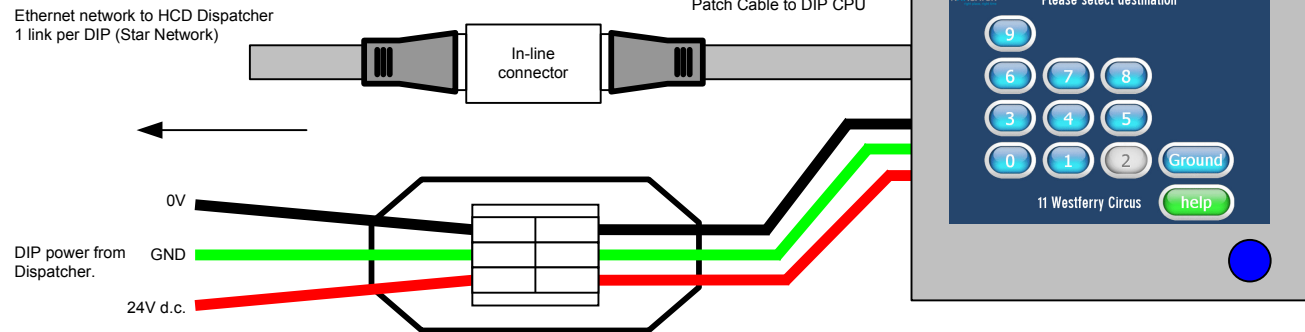

Specification

Keypad

Supply Voltage	24 V d.c. (24, 0V and Earth)
Operating Current	0.5A.
Dimensions	465 x 175 x 65 mm
Fixings	Various options on mounting plate.

Touch Screen

Supply Voltage	24 V d.c. (24, 0V and Earth)
Operating Current	1A.
Dimensions	355 x 355 x 60 mm
Fixings	Various options on mounting plate.

Precautions

The destination input panels (DIPs) must be mounted on a suitable wall using the supplied back plate.

Note:- Fixtures are not supplied as substrates for mounting are varied. Observe normal precautions for handling electronic devices, avoid static electricity, dampness and extreme temperatures. The shell contains fragile parts so treat the unit with extreme care. Please read this instruction sheet fully before use.

EMC Guidelines

It is extremely important that the following guidelines are adhered to. All Ethernet and 24V cable runs must be kept away from motor wiring, a separation of at least 300mm. Keep Ethernet and 24V wiring away from mains. If wiring has to cross any high voltage cable this must be done at right angles. DIPs must be mounted away from any high voltage equipment e.g. motors, door gear etc. Mains power input and motor output cables should be shielded and earthed as per panel drawings. Any screens must be earthed at both ends to low impedance earths.

Server Pin Entry Screen

To access the configuration when then system is running:- Navigate to the PIN entry screen. Call Screen > Help > Log On. Enter the PIN number (13527 default). Then go to Help > Toolbox > Dip Config. This closes the browser window on the DIP to access the configuration screens.

Keypad (TACDIP)

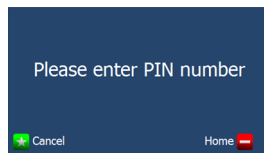

Touch Screen (TOSDIP)

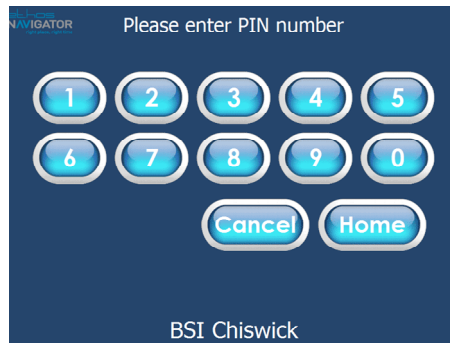

Fault Screen

This screen will be active if the device is not on the network or both servers have failed or not started. The help key will take the user to the PIN entry screen, to access the DIP setup screens overleaf.

Keypad (TACDIP)

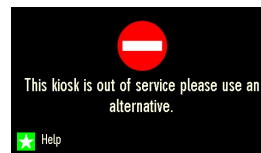

Touch Screen (TOSDIP)



Pin Entry Screen

Default Pin is "01352" This screen will time out and return to the fault screen

Keypad (TACDIP)



Touch Screen (TOSDIP)

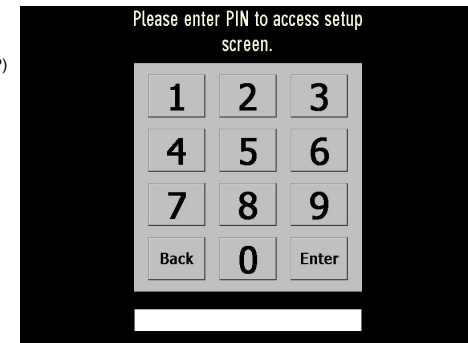

HCD System DIP Installation Sheet

We reserve the right to alter, without giving prior notice, technical data, dimensions and weights described in this manual.
 Thames Valley Controls Ltd Manor Farm Industrial Estate, Flint, Flintshire CH6 5UY
 (t): +44 (0) 1352 793222 (f): +44 (0) 1352 793255



Configuration Screen

Exit will close the application and return to the underlying operating system
Do not press the Exit button
 Run Application will launch the application and try to establish a link to the HCD server.

Keypad
 (TACDIP)

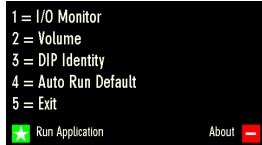

Touch
 Screen
 (TOSDIP)

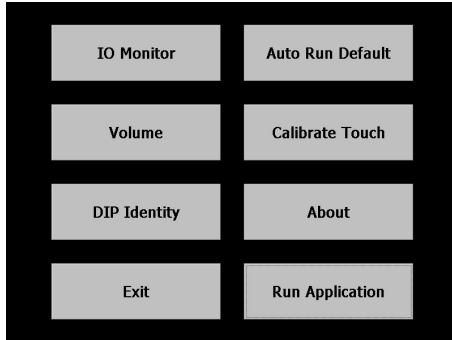

IO Monitor Screen

Confirms keys and pushes are working correctly.
 "d" is the disabled key.

Keypad
 (TACDIP)

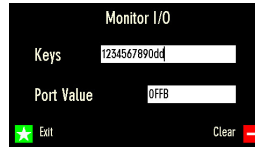

Touch
 Screen
 (TOSDIP)

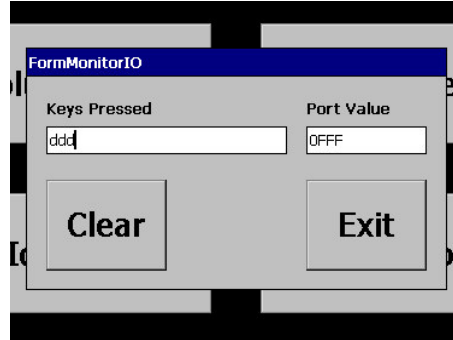

Volume Adjust Screen

Used to adjust volume. A hardware adjustment pot is also available on black amp unit within the DIP housing. **Do not alter tick boxes on Touch version.**

Keypad
 (TACDIP)

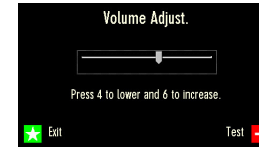

Touch
 Screen
 (TOSDIP)

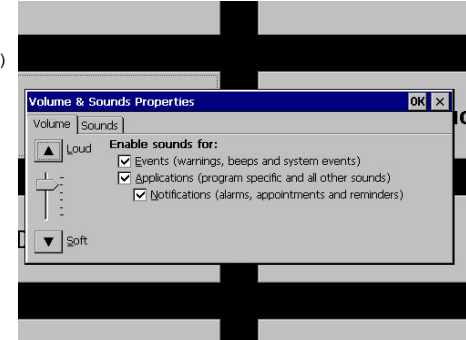

DIP Floor And Number Screen

Sets up DIP Floor level and number to match drawings. This also sets the IP address of the device, e.g. 191.100.2.3 would be the 3rd DIP on Floor 2.
These settings are factory set; they should not be changed on a pre-configured system.

Keypad
 (TACDIP)

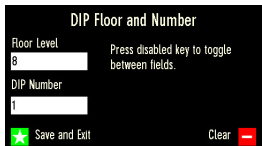

Touch
 Screen
 (TOSDIP)

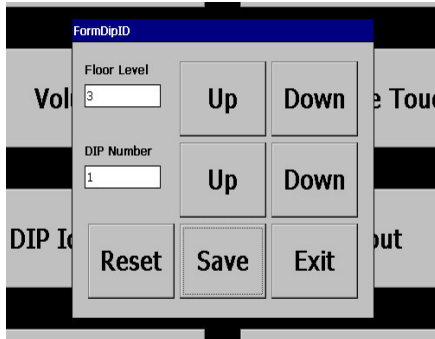

Auto Run Screen

This sets the application to "Auto Run" on power up.
 The screen is used if you wish to stop the program running on boot up.
 The application is normally set to launch on boot. **Do not press the NO button.**

Touch Screen (TOSDIP)

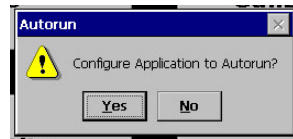

Keypad (TACDIP)

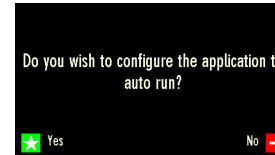

About Screen

These screens show the current software version / IP address of the device (hence DIP number and Floor) and also the server the device is talking to. If no server is active or the DIP has connection problems, this line will be blank.

Keypad
 (TACDIP)

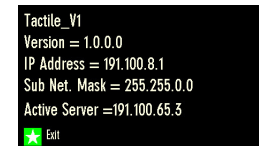

Touch
 Screen
 (TOSDIP)

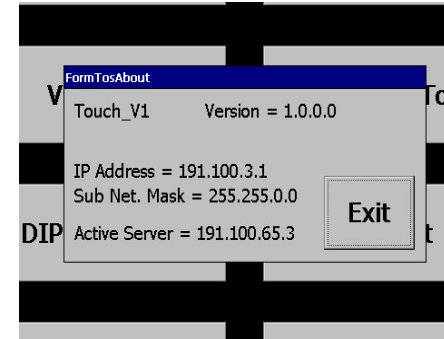

Touch Screen Calibration

This screen is used to calibrate the touch screen, follow instructions as they appear.
Note: this screen is not available on the keypad version.

