

# LX8 emFONE

## Installation and Configuration

**TVL No. 336**

**Issue No. 1**

**03/10/2011**

## Contents

		Page	
<b>Pre-Installation</b>	<b>Pre-Installation Requirements</b>	<b>3</b>	
<b>Installation</b>	<b>Installation Procedure</b>	<b>3</b>	
<b>Configuration</b>	<b>Alarm Debounce</b>	<b>4</b>	
	<b>Bus Scan</b>	<b>5</b>	
	<b>Customization Parameter Programming</b>	<b>5</b>	
	<b>Lift Mapping / Master Controller Ring Time</b>	<b>10</b>	
	<b>Master Controller Speaker Setting</b>	<b>11</b>	
	<b>Programming Station Location</b>	<b>12</b>	
	<b>Programming Station Location(Console Operation)</b>	<b>13</b>	
	<b>Reporting</b>	<b>14</b>	
	<b>Station Speaker And Microphone Setting</b>	<b>15</b>	
	<b>Station SL Scream Detection Setting</b>	<b>16</b>	
	<b>System Setup for Data Transmission</b>	<b>18</b>	
	<b>Telephone Setup</b>	<b>20</b>	
	<b>Voice Message</b>	<b>23</b>	
	<b>Operation</b>	<b>Alarm Calls</b>	<b>25</b>
		<b>Battery Operation</b>	<b>26</b>
<b>Calling Get Number</b>		<b>26</b>	
<b>Dialling In</b>		<b>27</b>	
<b>Intercom Calls</b>		<b>28</b>	
<b>LX8 Master Controller User Interface</b>		<b>31</b>	
<b>Station SK User Interface</b>		<b>32</b>	
<b>Station SL User Interface</b>		<b>33</b>	
<b>Press To Talk</b>		<b>34</b>	
<b>Resetting Alarms</b>		<b>34</b>	
<b>Maintenance</b>	<b>Firmware Upgrades</b>	<b>35</b>	
	<b>Station Car Self Test</b>	<b>36</b>	
<b>Reference</b>	<b>Remote Handset Keypad Commands</b>	<b>37</b>	
	<b>LX8M Master Controller Dimensions</b>	<b>41</b>	
	<b>LX Intercom System Electrical Specifications</b>	<b>42</b>	
	<b>LX-TE Wiring Diagram And Dimensions</b>	<b>43</b>	
	<b>Station Programming Keypad Commands</b>	<b>44</b>	
	<b>Station SK Unit Dimensions</b>	<b>46</b>	
	<b>Station SK Wiring Diagram</b>	<b>46</b>	
	<b>Station SL Unit Dimensions</b>	<b>47</b>	
<b>Station SL Wiring Diagram</b>	<b>47</b>		

## Pre-Installation Requirements

There are a number of requirements for a site before an installation of an LX-8 system can occur. These include:

- Standard mains power supply where the Master Controller will be installed.
- Activated telephone line with RJ-11 terminated cable to be plugged into the Master Controller.
- 2 x 24 AWG twisted pair shielded cable to all points within the system. Care must be taken when installing this cable as induced noise onto it may cause issues and prevent the system from operating at its peak.
- Appropriate mounting holes / studs at each location.

## Installation Procedure

### ***Master Controller***

1. Mount the Master Controller using the provided mounting holes.
2. Verify that the power switch is set to the OFF position.
3. Connect the supplied power adapter.
4. Connect the backup battery.
5. Connect the telephone line.
6. Connect the 4-wire bus.
7. Set the power switch to the ON position. You should see some LED's turn on.

### ***Car Stations – Station SL***

1. Mount the Station using the provided mounting holes.
2. (If applicable) Mount the external speaker and microphone to the panel, and connect the 4-way connector to the Station.
3. (If applicable) Connect the relay outputs of the Station to the desired external circuitry.
  - a. Relay 1: Alarm acknowledged
  - b. Relay 2: Call answered
4. Connect the Lift's alarm button to the provided 4-way terminal.
5. Connect the 4-wire bus to the 5-way terminal.
6. Connect the 5-way terminal to the Station. You should hear a series of beeps indicating a successful power-up sequence.

### ***External Stations – Station SK***

1. Connect the 4-wire bus to the unit. You should hear a series of beeps indicating a successful power-up sequence.
2. Mount the Station using the provided mounting holes.



# Configuration

## Alarm Debounce

The external alarm button on Station SL must be de-bounced before the Station raises an alarm. Alarm De-bounce Time is the amount of time the external alarm button must be kept pressed before the Station raises an Alarm. It is also called Alarm Button Time. The De-bounce Time ranges from 1 to 9 seconds and can be programmed via the keypad on the Station, from the Master Controller, and via the remote handset.

### Programming via Station Keypad

The Station must be put in programming mode before programming the Debounce Time. Below are the steps to be followed:

1. Put the Station into Programming Mode by pressing and holding the  button for 3 seconds.
2. The Station enters Programming Mode by giving 4 beeps.
3. Enter the following programming sequence

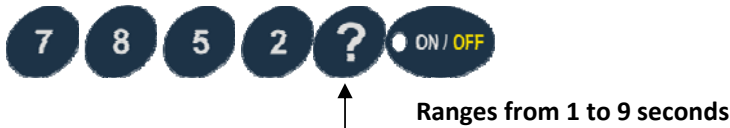

4. The Station will sound 2 beeps after successful programming.
5. Exit the Programming Mode by pressing and holding the  button for 3 seconds. The Station will sound 3 beeps when it exits Programming Mode.
6. If the Station is not made to exit Programming Mode manually, it will automatically exit after 7 seconds. It will sound 3 beeps when it exits Programming Mode.

### Programming via LX8 Master Controller

The LX8 Master Controller has LCD Menus to program the Debounce Time (Alarm Button Time).

1. In the LX-8 Main Menu, enter the menu '**Configure System**'. When you do so, you will be prompted for a pin.
2. Enter the Programming Pin\*. If it is successful, you will enter the '**Program Settings**' Menu.
3. Select the option '**Ph. Settings**'.
4. Scroll down to the menu '**Enter Alarm Button Time**'. Enter the debounce value and press Enter.
5. Go back to the main menu. At this point, the Debounce Time will be broadcast to all Station SLs.

### Programming via remote handset

The Debounce Time can be programmed via a remote handset while in conversation with the LX-System. The Debounce Time is one of the parameters in Telephone Options. Enter the following keypad sequence to program the Debounce Time.

- Telephone Options
  - Programming Sequence:

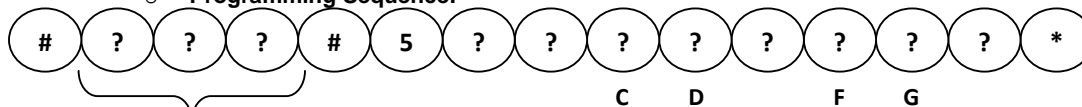

Programming PIN

Alarm Button Time Range is 1-9 seconds

- A: Dial time (1-9) x 5 seconds (Default:5)
- B: Talk time (1-9) x 2 minutes (Default: 2)
- C: Silence time (1-9) x 5 seconds (Default: 4)
- D: **Alarm button timer (De-bounce Time) (1-9) seconds (Default: 3)**
- E: Auto-answer ring count (1-9) x 2 (Default:1)
- F: Auto-answer enable (0,1)(Default:1 (Enable))
- G: Ringer Control (0,1)(Default:1 (Enable))
- H: PABX Continuous tone detection enable (0,1)(Default:1 (Enable))

- Verification sequence:



The Debounce Time will be broadcast after the call is finished. \* **NOTE: The default Programming PIN is 123**

# Configuration

## Bus Scan

The LX Master Controller must identify all the Stations that are connected to it before the system will operate as per the specification. The Master Controller, as a factory default, will only identify Stations Top, Car, Pit, and Spare on Lift 1. If more Stations are connected to the bus, then the Master Controller must scan the bus for all the Stations that are connected and are active. Following is a description of how to scan the bus on the LX8 Master Controller.

### LX8 Master Controller

1. In the LX-8 Main Menu, select the option '**Check Station Status**'.
2. You will see a screen shot that says '**Please Wait ...**' while the Master Controller scans the bus for the Stations.
3. After the scan, the LCD will show the '**System Status**'.
4. The '**Active Stations**' section in the '**System Status**' screen shot will give a list of all the Stations that are Active. You can scroll up and down to see all the Stations.
5. Pressing '**END**' will take you back to the main menu. The Master Controller will automatically exit '**System Status**' if '**END**' is not pressed for one minute.
6. Please note that the Lift Numbers shown under '**Active Stations**' are the Mapped Lift Numbers. Please refer to '**Lift Mapping Master Controller Ring Time**' section for more information about Mapped Lift Numbers.

## Customization Parameter Programming

This section covers programming of certain parameters for additional customization of the LX Intercom System. These parameters can be programmed both from the LX8 Master Controller and also from a remote handset. The LX8 Master Controller has LCD Menus to program the parameters.

### Programming via LX8 Master Controller

Following are the steps to be followed to program parameters via the LCD Menus on the LX8 Master Controller:

1. In the LX-8 Main Menu, enter the menu '**Configure System**'. When you do so, you will be prompted for a pin.
2. Enter the Programming Pin\*. If it is successful, you will enter the '**Program Settings**' Menu.

Each of the parameters have their own menus or screen shots that guide you with the permissible values for the parameter. Given below is a list of parameters and a description of their screen shots/menus.

Program Settings	
<b>Ph. Settings</b>	Enter Dial Time
	Enter Talk Time
	Enter Silence Time
	Enter Alarm Button Time
	Enter Auto-Answer Ring Count
	Enter Auto-Answer Enable
	Enter Ring Control
	Enter Continuous Tone Detect
	Enter Volume Setting
<b>Voice Settings</b>	Digital Voice Setting
<b>Relay Option</b>	Enter Relay Option
<b>Relay ON Time</b>	Enter Relay ON Time
<b>DTMF Settings</b>	Enter DTMF Tx Attenuation
<b>Busy Tone Cadence</b>	Enter Busy Tone Cadence
<b>Ring Time</b>	Enter Master Ring Time
<b>Settings PIN</b>	Enter New PIN
<b>Get #</b>	Enter Get #
<b>Enable Reporting</b>	Enter Reporting Enable
<b>Reporting #</b>	Enter Reporting #
<b>Reporting Frequency</b>	Enter Reporting Frequency
<b>Alarm PIN</b>	Enter Alarm PIN
<b>Self Test Enable</b>	Enter Self Test Enable
<b>Operation Mode</b>	Enter Operation Mode



- **Ph. Settings:**
  - **Enter Dial Time:**
    - The Range is 1 -9, x5 seconds if in normal operation mode
    - The Range is 1 -9, x10 seconds if in a switch/console mode
    - Factory Default is 5
  - **Enter Talk Time:**
    - The Range is 1-9, x2 minutes.
    - Factory Default is 2
  - **Enter Silence Time:**
    - The Range is 1-9, x5 seconds; 0=Disabled
    - Factory Default is 4
  - **Enter Alarm Button Time:**
    - The Range is 1-9, x1 second.
    - Factory Default is 3
  - **Enter Auto-Answer Ring Count:**
    - The Range is 1-9, x2 Rings.
    - Factory Default is 1
  - **Enter Auto-Answer Enable:**
    - 0=Disabled 1=Enabled
    - Factory Default is 1
  - **Enter Ring Control:**
    - 0=Off, 1=On.
    - Factory Default is 1
  - **Enter Continuous Tone Detect:**
    - 0=Disabled 1=Enabled
    - Factory Default is 1
  - **Enter Volume Setting:**
    - The Range is 0-min 9-max
    - Factory Default is 5
- **Voice Settings:**
  - **Digital Voice Setting**
    - 0=Disabled;1=Played upon Answer;2=Played when requested;3=Non-programming voices disabled;4=Every 1 Minute
    - The Factory Default is 1
- **Relay Option:**
  - **Enter Relay Option**
    - 0=Disabled; 1=Line ON; 2=Any Fault; 3=Call Answer; 4=Code Sent;5=EMU
    - The Factory Default is 3
- **Relay ON Time:**
  - **Enter Relay ON Time**
    - The Range is 1-9, x2 seconds.
    - The Factory Default is 2
- **DTMF Settings:**
  - **Enter DTMF Tx Attenuation**
    - The Range is 0(min) to 9(max).
    - The Factory Default is 3
- **Busy Tone Cadence:**
  - **Enter Busy Tone Cadence**
    - 0=210ms to 750ms; 1=60ms to 750ms
    - The Factory Default is 0
- **Settings PIN:**
  - **Enter New PIN**
    - Enter a 3 digit pin, which will be your new programming pin.
    - The Factory Default is 123
- **Get #:**
  - **Enter PABX #**
    - Enter the PABX dial out number, if any. If none, simply press enter
    - The Factory Default is empty.
  - **Enter Number**
    - Enter the phone number.
    - The Factory Default is 12722123
- **Alarm PIN:**
  - **Enter Alarm PIN**
    - **Enter PIN Location**
      - Range is 1-8
    - **Enter PIN**
      - 4 digit pin
      - The Factory Default is 1234 for all locations.



- **Self Test Enable:**
  - **Enter Self Test Enable**
    - 0=Disabled 1=Enabled
    - Factory Default is 0
- **Operation Mode:**
  - **Enter Operation Mode**
    - 1=Switch 0=Normal
    - Factory Default is 0

### Factory Default

There is a menu option that defaults the parameters to their factory default setting. Please exercise caution when using this option as this resets the parameters to their factory default and might be different to your particular site. Follow the steps given below to do a factory reset.

1. In the LX-8 Main Menu, enter the menu '**Configure System**'. When you do so, you will be prompted for a pin.
2. Enter the Programming Pin. If it is successful, you will enter the '**Program Settings**' Menu.
3. Scroll down to the '**Factory Default**' menu option.
4. A warning banner message that says '**!Reset to Factory Default!**' will be displayed. Press '**ENTER**' to do a factory default setting, or press '**END**' if you are not sure.

Following is a table of parameters that will get affected by a factory reset.

SL. No.	Parameter	Value	
1.	<b>First Help Number</b>	12722123	
2.	<b>Help Numbers (2-9) and Maintenance Numbers</b>	Erased	
3.	<b>Programming Pin</b>	123	
4.	<b>Get Number</b>	12722123	
5.	<b>Telephone Options</b>	Dial Time	25 seconds
		Talk Time	4 minutes
		Silence Time	20 seconds
		Alarm Button Time	3 seconds
		Auto Answer Ring Count	2 Rings
		Auto Answer Enable	1 (Enable)
		Ringer Control	1(Enable)
		PABX Continuous Tone Detect Enable	1(Enable)
6.	<b>Transmit and Receive Gain</b>	3	
7.	<b>Busy Tone Cadence</b>	0 (210 ms – 750 ms)	
8.	<b>Master Controller Ring Time</b>	10 seconds	
9.	<b>Digital Voice</b>	1 – Played upon answer of emergency call(Normal Operation) 0 – Disabled (Console Operation Mode)	
10.	<b>Relay Options</b>	3 – Call answered	
11.	<b>Relay ON Time</b>	4 seconds	
12.	<b>Reporting</b>	Reporting Enable	0 (Disabled)
		Reporting Number	13451074
		Reporting Frequency	1 Day
13.	<b>Alarm PINs (All 8)</b>	1234	
14.	<b>Speaker Volume</b>	5	
15.	<b>Self Test Enable</b>	0 (Disabled)	
16.	<b>Operation Mode</b>	0 (Normal)	



## Verifying Parameters via LCD Menus

The parameters on the LX8 Intercom System can be verified via the LCD Menus or via the remote handset. Following are the steps to verify via the LCD Menus.

1. In the LX8 Main Menu, enter the 'Verify Settings' menu option.
2. Scroll down to your desired parameters and press 'ENTER'.
3. The next screen shot will show you the parameter value.

## Programming and Verifying via the Remote Handset

Parameters on the LX8 Intercom System can be programmed via the remote handset while in conversation with the system. Following are the keypad sequences to be entered on the remote handset to program or verify the parameters on the LX8 Intercom System.

### • Telephone Options

#### ○ Programming Sequence:

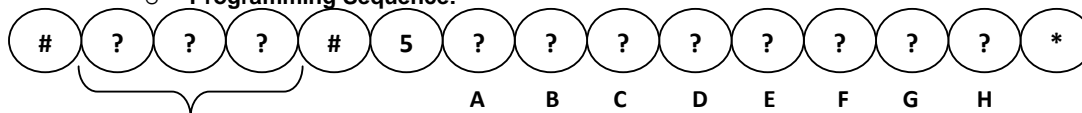

#### Programming PIN

- **A:** Dial time (1-9) x 5 seconds (Default:5)
- **B:** Talk time (1-9) x 2 minutes (Default: 2)
- **C:** Silence time (1-9) x 5 seconds (Default: 4)
- **D:** Alarm button timer (Default: 3)
- **E:** Auto-answer ring count (1-9) x 2 (Default:1)
- **F:** Auto-answer enable (0,1)(Default:1)
- **G:** Ringer Control (0,1)(Default:1 (ON))
- **H:** Continuous tone detection enable (0,1)(Default:1 (Enabled))

#### ○ Verification Sequence:



### • Digital Voice and Relay:

#### ○ Programming Sequence:

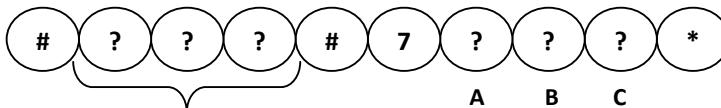

#### Programming PIN

- **A - Digital voice message: (Default : 1)**
  - 0: Disabled
  - 1: Played upon answer of emergency call
  - 2: Played only when requested
  - 3: All non-programming voices disabled
  - 4: Every 1 Minute
- **B - Relay options: (Default : 3)**
  - 0: Disabled
  - 1: Line on
  - 2: Any fault
  - 3: Call answered
  - 4: Code sent
  - 5: EMU
- **C - Relay ON time (Range (1-9) x 2 s; Default : 2)**

#### ○ Verification Sequence:





- **Programming New 'Programming PIN'**

- **Programming Sequence:**

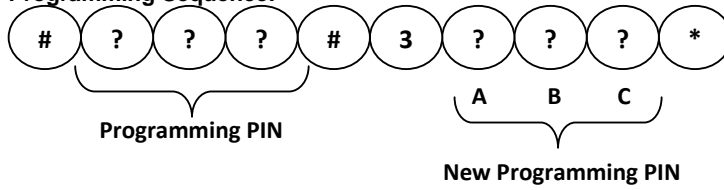

- **Programming Get Number**

- **Programming Sequence:**

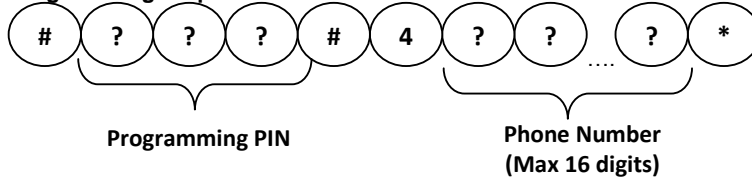

- **Verification Sequence:**

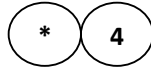

- **Transmit and Receive Gains**

- **Programming Sequence:**

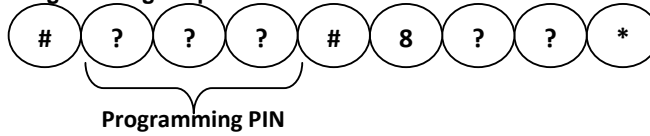

- **A:** DTMF Transmit Adjustment (Range: 0(min)-9(max); Default: 3)
- **B:** Busy Tone Cadence (0=210ms-750ms; 1=60ms-750ms; Default: 0)

- **Verification Sequence:**

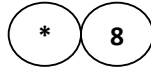

- **Alarm PIN**

- **Programming Sequence:**

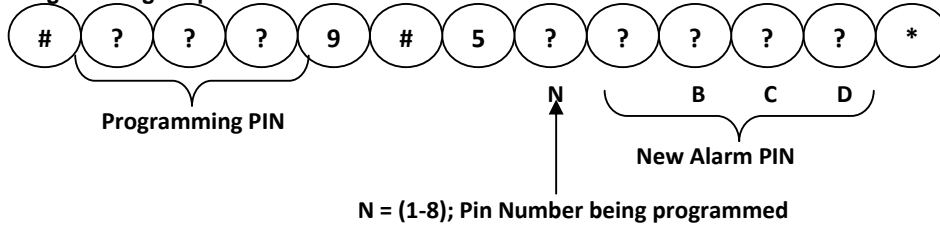

- **Verification Sequence:**

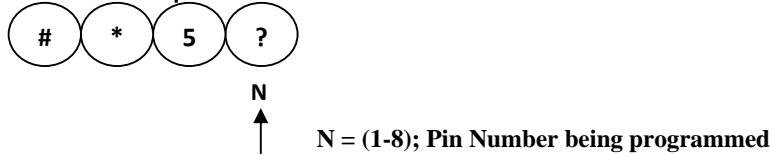

- **Self Test Enable**

- **Programming Sequence:**

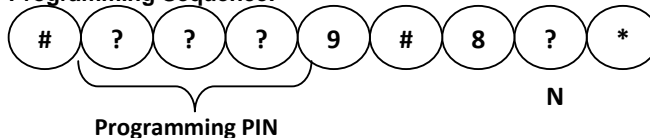

- **N:** 1 = Enabled 0 = Disabled

- **Verification Sequence:**



- **Firmware Version**  
Play the current version of the firmware on the LX8 Master Controller.
  - **Verification Sequence:**

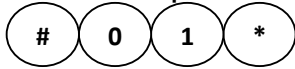

\* **NOTE:** The default Programming PIN is 123

## Lift Mapping

The LX8 Master Controller support 8 lifts. The lifts are numbered 1 to 8 on the LX8 System. However, the actual lift numbers that the Stations are installed in depend on individual sites. For example, a site could have its lifts numbered 20 to 27. For ease of identification, the lifts, numbered 1 to 8 on the LX8 System, can be numbered or mapped to a two digit number ranging from 01 to 99. For example, if Lift 1 on the LX8 System is mapped to Lift Number 20, then Lift 1 is represented as Lift 20. Hence, when a Station raises an alarm from Lift 20, then the identification message will identify the lift as Lift 20. The example shown below gives a description of how the Lifts on the LX8 System can be mapped to the Site Lift Numbers.

LX8 System Lift Numbers	Site Lift Numbers
Lift 1	Lift 20 (Mapped to Lift 1 on LX8)
Lift 2	Lift 21 (Mapped to Lift 2 on LX8)
Lift 3	Lift 30 (Mapped to Lift 3 on LX8)
Lift 4	Lift 31 (Mapped to Lift 4 on LX8)
Lift 5	Lift 40 (Mapped to Lift 5 on LX8)
Lift 6	Lift 41 (Mapped to Lift 6 on LX8)
Lift 7	Lift 50 (Mapped to Lift 7 on LX8)
Lift 8	Lift 51 (Mapped to Lift 8 on LX8)

Following are the steps to number/map the lifts.

### ***LX8 Master Controller***

#### **Programming**

1. In the LX-8 Main Menu, enter the menu 'Configure System'. When you do so, you will be prompted for a pin.
2. Enter the Programming Pin\*. If it is successful, you will enter the 'Program Settings' Menu.
3. Select 'Lift Numbering' menu option.
4. The 'Enter Lift Number (01-99)' screen will give you options to number/map Lift 1 to Lift 8 on the LX8 System to the two digit Lift Number you desire.

#### **Verifying**

1. In the LX-8 Main Menu, enter the menu 'Verify Settings'.
2. Select the 'Lift Numbering' in 'Verify Settings' menu.
3. The lift mapping will be shown in a single screen shot.

### **Master Controller Ring Time**

Master Controller ring time is the time the Master Controller rings before it starts dialling out a help number when it acknowledges an alarm from a Station. It ranges from 0 to 99 seconds. If the ring time is 0, then the Master Controller starts dialling without ringing.

The ring time can be programmed via the LX8 Master Controller LCD menus and via the remote handset  
Following are the steps to program Master Controller Ring time.

### ***LX8 Master Controller***

#### **Programming**

1. In the LX-8 Main Menu, enter the menu 'Configure System'. When you do so, you will be prompted for a pin.
2. Enter the Programming Pin\*. If it is successful, you will enter the 'Program Settings' Menu.
3. Select 'Ring Time' menu option.
4. In the screen shot 'Enter Ring Time', enter the desired ring time and press 'ENTER'.

## Verifying

1. In the LX-8 Main Menu, enter the menu 'Verify Settings'.
2. Select the 'Master Ring Time' in 'Verify Settings' menu.
3. The Master Controller ring time will be shown in a single screen shot.

## Programming via Remote Handset

The Master Controller ring time can be programmed via a remote handset while in conversation with the LX System. Following is the keypad sequence

- Master Controller ring time
  - Programming sequence:

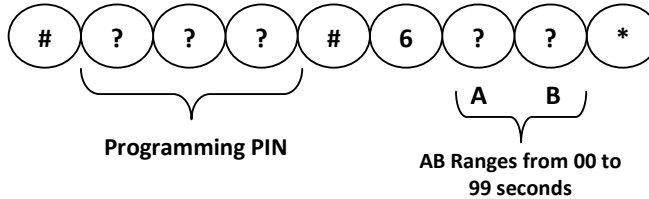

- Verification sequence:

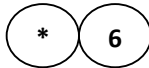

A voice message that says "Sequence Accepted" indicates successful programming.

- NOTE: The default Programming PIN is 123

## Master Controller Speaker Setting

The speaker volume on the LX8 System Master Controller is programmed via the LX8 Master Controller LCD menu interface or via the remote handset

### Programming via LX8 Master Controller

#### Programming

The LX8 Master Controller has LCD Menus to program the speaker volume.

6. In the LX-8 Main Menu, enter the menu '**Configure System**'. When you do so, you will be prompted for a pin.
7. Enter the Programming Pin. If it is successful, you will enter the '**Program Settings**' Menu.
8. Select the option '**Ph. Settings**'.
9. Scroll down to the menu '**Enter Volume Setting**'. Enter the volume in the range 0(min) to 9(max).
10. A '**Success**' message will be displayed.

#### Verifying

4. In the LX-8 Main Menu, enter the menu '**Verify Settings**'.
5. Select the '**Ph. Settings**' menu option.
6. Scroll down to '**Volume Setting**' screen shot and press '**ENTER**'

### Programming via Remote Handset

The LX Master Controller speaker volume can be programmed via a remote handset while in conversation with the LX System. Following is the remote handset keypad sequences to program speaker setting.

- Master Controller Speaker Level Setting:
  - Programming sequence:

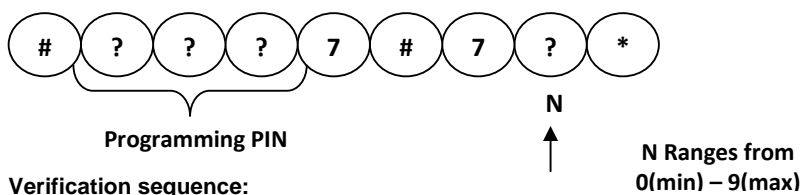

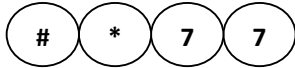

A voice message that says "Sequence Accepted" indicates successful programming.

## Programming Station Location

A Station must have its location programmed before it will operate as per the specifications. Stations are grouped logically (usually by their lift number) and each assigned a position within the lift. The lift number ranges from 1 to 8 and the position within the lift are Top, Car, Pit, and Spare. Top refers to top of the lift; Car refers to in the lift car; Pit refers to in the pit, and Spare refers to a spare Station. The Station Location can only be programmed via the keypad on the Station. The Station must be put in Programming Mode before programming the Station Location. Following are the steps to be followed

- **Station SK**

7. Put the Station into Programming Mode by pressing and holding the  button for three seconds.
8. The Station enters Programming Mode by giving 4 beeps.
9. Enter the following programming sequence



- **L** – Lift Number from 1 to 8
- **P** – Position; Top – 1; Car – 2; Pit – 3; Spare – 4

10. The Station will sound 2 beeps after successful programming.
11. Exit the Programming Mode by pressing and holding the  button for three seconds. The Station will sound 3 beeps when it exits Programming Mode.
12. If the Station is not made to exit Programming Mode manually, it will automatically exit after 7 seconds. It will sound 3 beeps when it exits Programming Mode.

- **Station SL**

1. Put the Station into Programming Mode by pressing and holding the  button for three seconds.
2. The Station enters Programming Mode by giving 4 beeps.
3. Enter the following programming sequence



- **L** – Lift Number from 1 to 8
- **P** – Position; Top – 1; Car – 2; Pit – 3; Spare – 4

4. The Station will sound 2 beeps after successful programming.
5. Exit the Programming Mode by pressing and holding the  button for three seconds. The Station will sound 3 beeps when it exits Programming Mode.
6. If the Station is not made to exit Programming Mode manually, it will automatically exit after 7 seconds. It will sound 3 beeps when it exits Programming Mode.

## Programming Station Location (Console Operation)

A Station must have its location programmed before it will operate as per the specifications. Stations are grouped logically (usually by their lift number) and each assigned a position within the lift.

In Console/Switch Operation Mode, the Station Location Address is physically mapped to the Console Key press and the line number. The table titled '**Console Operation**' gives information about the Station Location Address. The last column in the table, titled '**Low Level Address (LX/S)**' is the Station Location that needs to be programmed into the respective Station before operation.

The Station Location can only be programmed via the keypad on the Station. The Station must be put in Programming Mode before programming the Station Location.

Following are the steps to be followed

### • Station SK

1. Put the Station into Programming Mode by pressing and holding the  button for three seconds.
2. The Station enters Programming Mode by giving 4 beeps.
3. Enter the following programming sequence



- L – Left Hand Side Digit in the Column 'Low Level Address'
- R –Right Hand Side Digit in the Column 'Low Level Address'

4. The Station will sound 2 beeps after successful programming.
5. Exit the Programming Mode by pressing and holding the  button for three seconds. The Station will sound 3 beeps when it exits Programming Mode.
6. If the Station is not made to exit Programming Mode manually, it will automatically exit after 7 seconds. It will sound 3 beeps when it exits Programming Mode.

### • Station SL

1. Put the Station into Programming Mode by pressing and holding the  button for three seconds.
2. The Station enters Programming Mode by giving 4 beeps.
3. Enter the following programming sequence



- L – Left Hand Side Digit in the Column 'Low Level Address'
- R –Right Hand Side Digit in the Column 'Low Level Address'

4. The Station will sound 2 beeps after successful programming.
5. Exit the Programming Mode by pressing and holding the  button for three seconds. The Station will sound 3 beeps when it exits Programming Mode.
6. If the Station is not made to exit Programming Mode manually, it will automatically exit after 7 seconds. It will sound 3 beeps when it exits Programming Mode.

# Reporting

The LX Intercom System has the capability of reporting system information to a remote Communication Centre at regular periods (reporting frequency) ranging from 1 to 30 days. The system will be setup to dial a Communication Centre on a regular basis to report its current status and alert it of any issues that may require attention. Calls will also be made in the event of alarms, or when an alarm is reset by an authorized person using their PIN. Following are the conditions that trigger a report

- Power fault for 15 minutes and when power returns (once per reporting period).
- Telephone fault for 15 minutes and when telephone line returns (once per reporting period).
- Alarm raised after helps numbers have been dialed.
- Alarm log reset.
- Faults on Car Stations such as Microphone-Speaker fault, Alarm button fault, and not responding.
- Every reporting period.
- Manual report.

The reporting frequency, phone number, enable/disable can be programmed via the LX8 Master Controller LCD Menus or via the remote handset.

## Programming via LX8 Master Controller

The LX8 Master Controller has LCD Menus to program the Reporting parameters. Following are the steps to be followed.

### Programming

1. In the LX-8 Main Menu, enter the menu '**Configure System**'. When you do so, you will be prompted for a pin.
2. Enter the Programming Pin\*. If it is successful, you will enter the '**Program Settings**' Menu.
3. Scroll down to the following menus to program the Reporting parameters.
  - a. '**Enable Reporting**' menu: To enable Reporting (0 = Disabled; 1= Enabled).
  - b. '**Reporting #**' menu: To enter the Reporting Telephone Number.
  - c. '**Reporting Frequency**': To enter the Reporting Frequency (1-30 Days).
4. Each of the above menus will have their respective screen shots to enter the parameters.
5. A '**Success**' message will be displayed upon successful programming.

**NOTE: Programming Reporting Telephone Number is similar to programming a help/maintenance number.**

### Verifying

1. In the LX-8 Main Menu, enter the menu '**Verify Settings**'.
2. Scroll down to the menus '**Reporting Enable**', '**Reporting #**', and '**Reporting Frequency**' to verify the respective programmed parameters.

## Programming via Remote Handset

The reporting parameters can be programmed via a remote handset while in conversation with the LX-System. Following are the remote handset keypad sequences to program Reporting parameters.

### • Reporting enable

- Programming sequence:

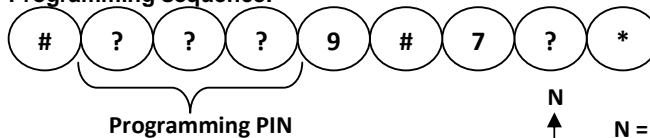

- Verification sequence:

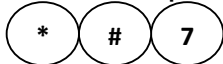

### • Reporting frequency

- Programming sequence:

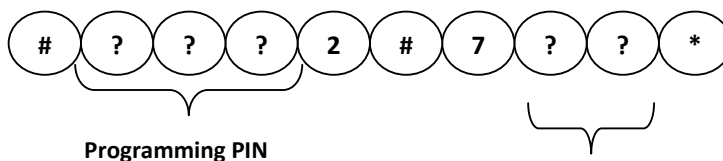

- Verification sequence:



**AB – Number of days between reports.  
Range: 01-30 days**

- **Reporting Telephone Number**
  - **Programming sequence:**

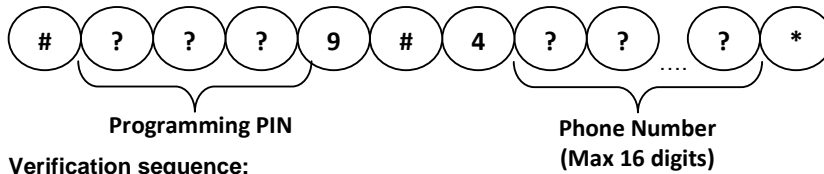

- **Verification sequence:**
- 

A voice message that says “Sequence Accepted” indicates successful programming.

#### **Manual Report from LX8 Master Controller**

The LX8 System can be made to report to the remote communication centre via LCD Menus.

1. Make sure that the Reporting is enabled and the correct Reporting Telephone Number has been entered into the System.
2. Scroll down the LX-8 Main Menu to ‘**Report**’ menu.
3. Select it and the LX8 Master Controller will initiate a manual report.

#### **Manual Report from a Remote Handset**

The LX System can be made to report to the communication centre from a remote handset.

- Dial into the System.
- After the System auto-answers (if enabled), enter the sequence given below on the keypad of the remote handset.



- Hang up the call.
- The Master Controller will start the reporting process.
- **NOTE: The default Programming PIN is 123**

## **Station Speaker And Microphone Setting**

The Station speaker and microphone setting is programmed via the Station keypad interface.

The Station must be put in Programming Mode before programming the speaker or microphone setting. Following are the steps to be followed

#### **Station SK Speaker and Microphone Setting**

1. Put the Station into Programming Mode by pressing and holding the  button for 3 seconds.
2. The Station enters Programming Mode by giving 4 beeps.
3. Enter the following programming sequence

- **Station SK Speaker Level Setting**



↑ Range: 1(min) – 8(max)

- **Station SK Microphone Level Setting**



↑ Range: 1(min) – 4(max)

4. The Station will sound 2 beeps after successful programming.

5. Exit the Programming Mode by pressing and holding the  button for 3 seconds. The Station will sound 3 beeps when it exits Programming Mode.
6. If the Station is not made to exit Programming Mode manually, it will automatically exit after 7 seconds. It will sound 3 beeps when it exits Programming Mode.

## Station SL Speaker and Microphone Setting

1. Put the Station into Programming Mode by pressing and holding the  button for 3 seconds.
2. The Station enters Programming Mode by giving 4 beeps.
3. Enter the following programming sequence
- o **Station SL Speaker Level Setting**



↑ Range: 1(min) – 8(max)

- o **Station SL Microphone Level Setting**



↑ Range: 1(min) – 4(max)

4. The Station will sound 2 beeps after successful programming.

5. Exit the Programming Mode by pressing and holding the  button for 3 seconds. The Station will sound 3 beeps when it exits Programming Mode.
6. If the Station is not made to exit Programming Mode manually, it will automatically exit after 7 seconds. It will sound 3 beeps when it exits Programming Mode.

### **Factory Default**

The factory default value for Microphone and Speaker Settings are as follows

- Microphone Setting – 2
- Speaker Setting – 5



## Changing Speaker Volume during Conversation

The Station speaker volume can be changed during conversation. When the volume (max or min) reaches its limit and can no longer be changed, the Station will sound 2 beeps. However, the speaker volume resets back to the programmed value after the end of the conversation when the Station returns to idle state.

- **Increasing Speaker Volume on Station SK:** Press
- **Decreasing Speaker Volume on Station SK:** Press
- **Increasing Speaker Volume on Station SL:** Press
- **Decreasing Speaker Volume on Station SL:** Press



## Station Scream Detection Setting

The Station scream detection setting is programmed via the Station keypad interface. The scream detection only exists on the SL version of the station interfaces.

The Station must be put in Programming Mode before programming the speaker or microphone setting. Following are the steps to be followed.

### Station SL Speaker and Microphone Setting

1. Put the Station into Programming Mode by pressing and holding the  button for 3 seconds.
2. The Station enters Programming Mode by giving 4 beeps.
3. Enter the following programming sequence
  - o **Station SL Scream Amplitude Threshold and Sample Time Settings**

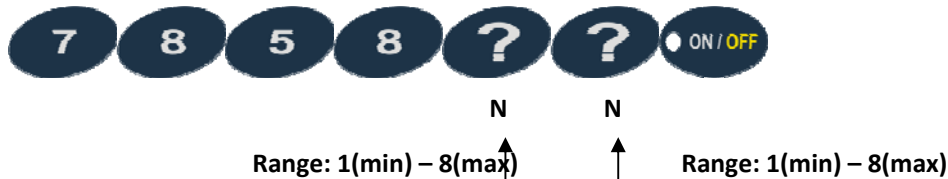

4. The Station will sound 2 beeps after successful programming.
5. Exit the Programming Mode by pressing and holding the  button for 3 seconds. The Station will sound 3 beeps when it exits Programming Mode.
6. If the Station is not made to exit Programming Mode manually, it will automatically exit after 7 seconds. It will sound 3 beeps when it exits Programming Mode.

### Factory Default

The factory default value for Scream Detection Unit is disabled.

### Disabling Unit

To disable the scream detection unit, enter the programming sequence stated above and enter 0 for any of the inputs. A figure of 0 in any of the two inputs disables the entire unit.

# System Setup for Data Transmission

Cabling used in the LX Intercom System must meet the specifications for the System to function as per the specification. Old cabling or cabling that does not meet the specification could cause the System to deviate from its specified functionality.

Following are the reasons that could cause functionality issues.

- Capacitive load on the cable is more than the specified limit.
- Cable resistance on the data bus is more than the specified limit.
- High noise on the data bus.

Bus Scans of the Stations connected will not be consistent if there are above mentioned issues on the data bus.

This section describes the steps to be taken in overcoming the issues mentioned above. There are two methods, which by themselves or in combination with each other, that can help resolve the problem depending on whether the problem is because of high capacitive loads, high cable resistance, or high cable noise. The two methods are:

1. Changing the load resistance on the data bus.
2. Changing the data bus voltage reference.

The following terminology is used in this document.

- **Terminology**
  - Data load port is set** – Load resistor on the corresponding unit is in-circuit.
  - Data load port is cleared** – Load resistor on the corresponding unit is out of circuit.

## Troubleshooting Issues due to High Capacitive Load on the Cable



Load resistors on the data bus of the Master Controller and the Station SLs can be varied to resolve this issue.

Follow the steps given below to ensure consistent data transmission.

1. Set the data load port on the Master Controller. Follow the steps given below to set the data load port on the Master Controller.
  - a. In the LX-8 Main Menu, enter the menu '**Configure System**'. When you do so, you will be prompted for a pin.
  - b. Enter the Programming Pin\*. If it is successful, you will enter the '**Program Settings**' Menu.
  - c. Scroll down to the menu option '**Set Dataload**'. If the menu option says '**Clear Dataload**', it means that the data load port is already set. Go to 'Step 2'. If the menu option says '**Set Dataload**', go to 'Step d' given below.
  - d. Press '**ENTER**'. You will notice that the menu option will change to '**Clear Dataload**'. This means that the data load port is set.
2. Scan the bus for Active Stations. Check to see if all the Stations that are connected have shown up in the Status after the scan.
3. If any Stations are missing, go to the next step. If none of the Stations is missing, scan a few times to see if the 'Bus Scan' is consistent and shows all Active Stations every single time. If the 'Bus Scan' is consistent, then the data bus can be considered as suitable for system operation.
4. You have reached this step because setting the data load port on the Master Controller has not helped in troubleshooting the issue. Go to the next step.
5. Set the data load port on Station SL using the keypad sequences shown in the section **Setting/Clearing Data Load Port on the Station SL**.
6. Scan the bus for Active Stations. Check to see if all the Stations that are connected have shown up in the Status after the scan.
7. If any Stations are missing, then go to the next Station SL that is connected and implement these steps from step 5 onwards.
8. Once you notice that all Stations are showing up after a 'Bus Scan', repeat the scan a few times to check for consistency.

## Setting/Clearing Data Load Port on the Station SL

The Station must be put in Programming Mode before setting or clearing the data load port on the Station SL. Following are the steps to be followed to

1. Put the Station into Programming Mode by pressing and holding the  button for 3 seconds.
2. The Station enters Programming Mode by giving 4 beeps.
3. Enter the following programming sequence
  - o **Setting the Data Load Port**  

  - o **Clearing the Data Load Port**  

4. The Station will sound 2 beeps after successful programming.

5. Exit the Programming Mode by pressing and holding the  button for 3 seconds. The Station will sound 3 beeps when it exits Programming Mode.
6. If the Station is not made to exit Programming Mode manually, it will automatically exit after 7 seconds. It will sound 3 beeps when it exits Programming Mode.

### Troubleshooting Issues due to High Cable Resistance

Data bus voltage reference can be lowered to resolve this issue. Data bus voltage reference is the optimum reference voltage for correct data detection by the microcontroller. The default value is 1.5v. This means that the swing in the voltage (peak-to-peak voltage) on the data bus should be more than 1.5v for correct data detection. Cable resistance that exceeds the limits can cause the data bus peak-to-peak voltage to be less than 1.5v. In this case, the data bus voltage reference must be reduced on the Master Controller and the Stations.

Reduce the data bus voltage reference to 1 V on the Master Controller and the Stations. The sections given below give the steps to change the data bus voltage reference on the Master Controller and the Stations.

After changing the data bus voltage reference on all the units, scan the bus for all Active Stations a few times and check if the scan is showing all connected Stations consistently.

**NOTE: For large cable resistance, you might have to clear the data load ports on the Master Controller and the Stations SLs for correct system operation.**

#### Changing Data Bus Voltage Reference on Master Controller

The data bus voltage reference on the Master Controller can be changed via the remote handset while in conversation with the System. The reference can be varied in steps of 0.5 Volts between 1 Volt and 3 Volt. Following are the keypad sequences.

- **Programming Sequence:**

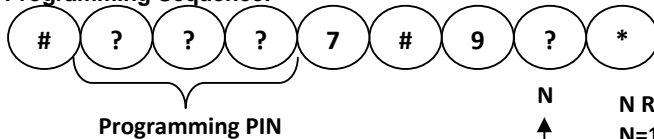

N Ranges from 1 to 5  
 N=1 =>1V  
 N=2=>1.5V  
 N=3=>2V  
 N=4=>2.5V  
 N=5=>3V

- **Verification Sequence:**

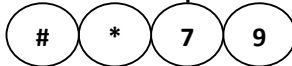

#### Changing Data Bus Voltage Reference on Station SL

Following are the steps to change the data bus voltage reference on Station SL.

1. Put the Station into Programming Mode by pressing and holding the  button for three seconds.
2. The Station enters Programming Mode by giving 4 beeps.
3. Enter the following programming sequence



N Ranges from 1 to 5  
 N=1 =>1V  
 N=2=>1.5V  
 N=3=>2V  
 N=4=>2.5V  
 N=5=>3V

4. The Station will sound 2 beeps after successful programming.
5. Exit the Programming Mode by pressing and holding the  button for three seconds. The Station will sound 3 beeps when it exits Programming Mode.
6. If the Station is not made to exit Programming Mode manually, it will automatically exit after 7 seconds. It will sound 3 beeps when it exits Programming Mode.

## Changing Data Bus Voltage Reference on Station SK

Following are the steps to change the data bus voltage reference on Station SK.

1. Put the Station into Programming Mode by pressing and holding the  button for three seconds.
2. The Station enters Programming Mode by giving 4 beeps.
3. Enter the following programming sequence

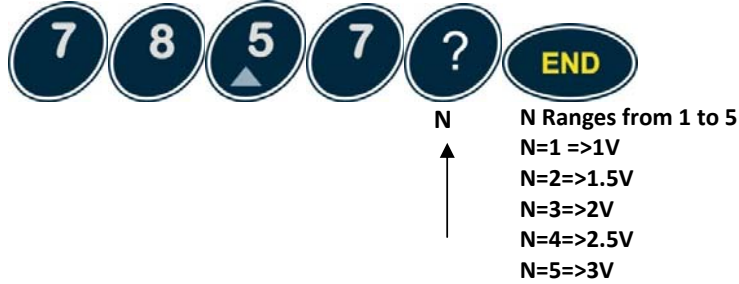

4. The Station will sound 2 beeps after successful programming.
5. Exit the Programming Mode by pressing and holding the  button for three seconds. The Station will sound 3 beeps when it exits Programming Mode.
6. If the Station is not made to exit Programming Mode manually, it will automatically exit after 7 seconds. It will sound 3 beeps when it exits Programming Mode.

## Troubleshooting Issues due to Noise on the Cable

Noise on the data bus can corrupt the data transmission. If the peak-to-peak voltage of noise is as high as the data bus voltage reference (Default = 1.5v) then the data will get corrupted. Hence, the data bus voltage reference must be increased to a value that is sufficiently higher than noise voltage. Use the steps given in the earlier sections to change the data bus voltage reference on the Master Controller and the Stations. After changing the data bus voltage reference on all the units, scan the bus for all Active Stations a few times and check if the scan is showing all connected Stations consistently.

**\* NOTE: The default Programming PIN is 123**

## Telephone Setup

The LX Intercom System automatically dials out Alarm Calls. The telephone numbers must be programmed before the unit will operate as per the specification.

A total of 12 phone numbers can be programmed into the Master Controller, 9 Help Numbers and 3 Maintenance Numbers. The Master Controller starts dialling out by dialling the first Help Number. If there is no response for the programmed dial time, the Master Controller hangs up and starts dialling the second Help Number and keeps dialling the Help Numbers in a sequence until there is a response. If none of the Help Numbers respond, then the Maintenance numbers are dialled in a sequence until there is a response.

When a Help Number that is in conversation with the Master Controller hangs up, the Master Controller dials the first Maintenance Number and keeps dialling the Maintenance Numbers in a sequence until there is a response. When a Maintenance numbers hangs up, the Master Controller ends the alarm call.

By default, the Maintenance numbers are not enabled.

### Programming Telephone Numbers

The telephone numbers can be programmed on the LX Master Controller via the Master Controller interface or the remote handset. Following sections describe programming via the Master Controller, and via the remote handset.

## Programming via LX8 Master Controller

### Programming

The LX8 Master Controller has LCD Menus to program the telephone numbers. Following are the steps to be followed.

1. In the LX-8 Main Menu, enter the menu '**Configure System**'. When you do so, you will be prompted for a pin.
2. Enter the Programming Pin\*. If it is successful, you will enter the '**Program Settings**' Menu.
3. Enter the '**Help #**' menu or the '**Maintenance #**' menu.
4. You will be shown the menu for either the Help Numbers or the Maintenance Numbers. You can scroll and enter the number you desire.
5. You can also enter the same phone number in all Help Number locations by selecting '**All Help Numbers**' in the '**Help #**' menu.
6. After you have selected the number you wanted to enter, you will be see a screen shot that prompts you to enter the phone number.
  - a. There are two sections in the phone number menu. The '**Enter PABX #**' section and the '**Enter Number**' section.
  - b. If you are using a PABX and there is a dial out number, enter it in the section '**Enter PABX #**', and press '**Enter**'. If there is no PAXB dial out number, simply press '**Enter**'
  - c. After the above step, you will see a section '**Enter Number**'. Enter the actual phone number and press '**Enter**'.
  - d. A phone number can be erased if you simply press '**Enter**' without entering any digits.
7. After successfully entering the phone number, you will see a message '**Success**' on the screen. An invalid phone number will show 'Invalid' on the screen.

### Verifying

The programmed phone numbers can be verified using the LCD Menus. Following are the steps to be followed.

1. In the LX-8 Main Menu, enter the menu '**Verify Settings**'.
2. Select the '**Help #**' or '**Maintenance #**' in the Verify Settings Menu.
3. Scroll up or down to verify the desired number.

### Redialling a Help Number

The LX Intercom System dials the Help Numbers in a sequence until there is a response. Hence, in-order to dial the same Help Number again and again until there is a response; the phone number should be programmed in all Help Number locations.

### Programming via Remote Handset

The telephone numbers can be programmed via a remote handset while in conversation with the LX-System. Following are the remote handset keypad sequences to program telephone numbers.

- **Help numbers (1 - 3)**

- **Programming sequence:**

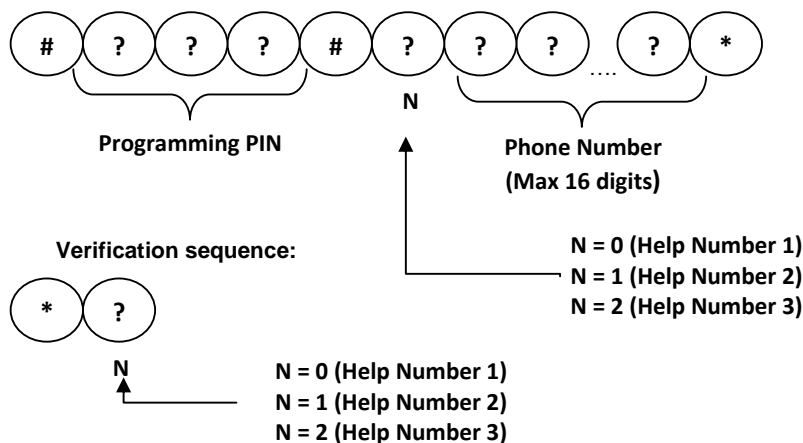

- **Help numbers (4 - 6)**

- **Programming sequence:**

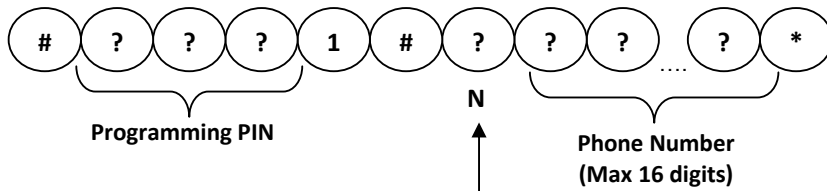

- **Verification sequence:**

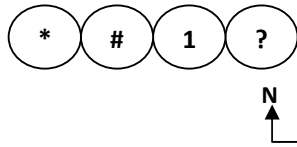

N = 0 (Help Number 4)  
 N = 1 (Help Number 5)  
 N = 2 (Help Number 6)

- **Help numbers (7 - 9)**

- **Programming sequence:**

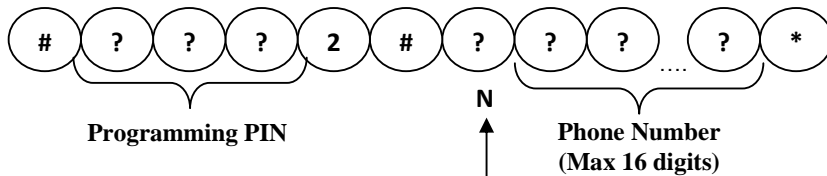

- **Verification sequence:**

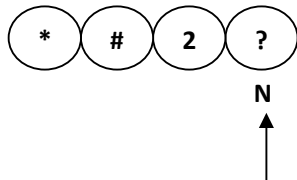

N = 0 (Help Number 7)  
 N = 1 (Help Number 8)  
 N = 2 (Help Number 9)

N = 0 (Help Number 7)  
 N = 1 (Help Number 8)  
 N = 2 (Help Number 9)

- **Help numbers (all 9)**

- **Programming sequence:**

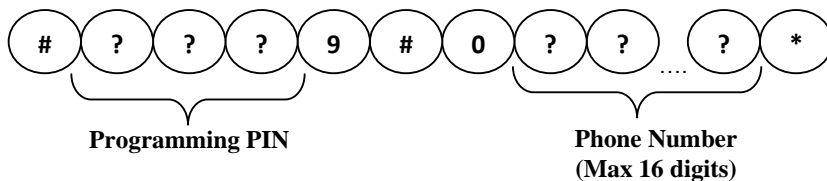

- **Maintenance numbers (1 - 3)**

- **Programming sequence:**

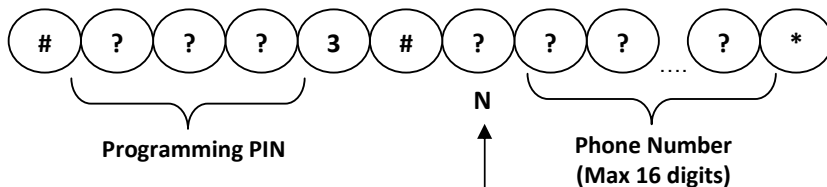

N = 0 (Maintenance Number 1)  
 N = 1 (Maintenance Number 2)  
 N = 2 (Maintenance Number 3)

- **Verification sequence:**





5. After you hear 'Sequence Accepted', start recording. Press **0** to finish recording. The maximum length of voice message is 16 seconds.

6. To verify voice message press **\* 9** on the remote handset keypad. Allow 3 seconds to pass after finishing recording and before verifying.

### ***Voice Record by dialing out of the unit***

1. Raise an alarm from any of the Stations.
2. Let it dial out. When the remote location responds and is in conversation with the Station, press **# #** on the remote handset to hang up the Station.
3. Now the Master Controller will be in a state in which voice can be recorded.
4. Enter the following sequence on the remote handset keypad.

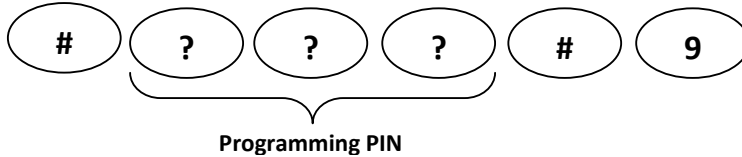

6. After you hear 'Sequence Accepted', start recording. Press **0** to finish recording. The maximum length of voice message is 16 seconds.

7. To verify voice message press **\* 9** on the remote handset keypad. Allow 3 seconds to pass after finishing recording and before verifying.



# Operation

## Alarm Calls

Alarm Calls can be raised from the Stations and the Master Controller. All Alarms raised will be serviced on a first-in-first-out basis.

Alarms take priority over Intercom Calls. Hence, in the event of an Alarm during an Intercom Call, the Intercom Call will be ended and the Alarm processed.

### **Alarm Calls from a Station**

- **Raising Alarm on Station SL**  
Press the button shown below on the Station SL Keypad to raise an alarm.



OR Press the external alarm button for the duration of the Alarm Debounce Time



- **Raising Alarm on Station SK**  
Press the button shown below on the Station SK Keypad to raise an alarm.



Alarm calls from different Stations are queued by the Master Controller and are serviced on a first-in-first-out basis. A voice message that says "Please hold, you are being connected to an emergency telephone" is played on the Station when the alarm is acknowledged by the Master Controller.

After the acknowledgement, the Station starts playing the ring tone until the call is serviced. A call can be serviced either by the Master Controller or by the programmed help/maintenance number.

When the Master Controller is ready to service an alarm call, it rings (if enabled) for the programmed period of time. The LCD on the Master Controller indicates the source of the alarm. Follow the prompts on the LCD screen on the Master Controller to accept

the call. The Alarm call can be accepted by either pressing the  button or by pressing the  button.

If no one answers on the Master Controller, then the Master Controller starts dialling out the first help number for the programmed dialling time. If there is no response, then the Master Controller starts dialling other programmed help numbers in a sequence until there is a response. If none of the help numbers respond, the Master Controller starts dialling the programmed maintenance numbers in a sequence until there is a response.

Please note that the Master Controller dials only if there is a valid phone number programmed.

In the event that the alarm call is not answered at all, then a voice message that says "Error" is played on the Station and the alarm call is ended. This could also happen if the telephone line is faulty or if phone numbers are not programmed.

### **Alarm Calls from Master Controller**

An alarm can be raised on the Master Controller by pressing the  button on the Master Controller keypad

The Master Controller starts the same dial-out sequence as that for Stations.

## Ending Alarm Calls

- **Ending Alarm on Station SK**  
Press the button shown below on Station SK to end an Alarm



- **Ending Alarm on Station SL**  
Press the button shown below on Station SL to end an Alarm



- **Ending Alarm on Master Controller**  
Press the button shown below on LX2 Master Controller to end an Alarm



When a help number hangs up on an alarm call, the Master Controller starts dialing the maintenance numbers (if they are programmed) until there is a response.

When a maintenance number hangs up, then the alarm call is ended.

### **Active Alarm**

The unit that raised the last alarm and was serviced by a help or a maintenance numbers is considered to be an active alarm after the end of the alarm call. An alarm call serviced from the Master Controller is not considered an active alarm after the end of the alarm call.

### **Master Controller as third-party in an Alarm Call**

The LCD on the Master Controller will show the Station that is in an Alarm Call. The Master Controller can join a call as a third party by following the prompt on the LCD screen.

## Battery Operation

The LX Intercom System has a back-up battery to supply power in the event of a power failure. The switch over to the back-up battery when there is a power failure is seamless and will not cause any system disruptions. To prevent the battery from discharging completely, the system cuts out power when it sees the battery voltage reach 10V.

### **Charge and Discharge Cycles**



The battery undergoes a continuous cycle of charge and discharge cycles. It is charged for 24 hrs and then discharged (or not charged) for a period of 72 hours.

On a System with all 32 Stations, a fully charged battery can supply power for about one hour before the System shuts down.

## Calling Get Number

Get Number is a service provided by Telstra, Australia to identify the phone number the unit is connected to. When the unit dials the Get Number, a voice message that says the phone number is played out by the telephone company.

To dial the Get Number:

1. Press the  button
2. The Master Controller will start dialing the Get Number
3. Once the call is answered by a remote party, a voice message plays out the phone number.
4. Hang-up the call by pressing the  button.

**NOTE: Please reprogram the 'Get Number' depending on your country specifications.**

# Dialing In

The LX Intercom System can be dialled into from a phone line. When an incoming phone call is detected by the LX System, it will auto-answer (if enabled) and play the pre-recorded voice identification message. After this, depending on the state of the system, several operations, which are listed below, are possible. They are as follows:

## Active Alarm Present

If there is an active alarm, then a voice message will identify the source of the alarm and the call is routed to the unit (Station or Master Controller) that had raised the alarm. The caller can then speak with the party that raised the alarm.

The voice message says “Lift Number [N1] [N2] [P]”, where

P is the Position of the Station (“Top”, “Car”, “Pit”, “Spare”)

N1 and N2 are the digits of the lift number (Range: 01 – 99)

For example, if the Alarm had been from a Station in the Car from Lift 25, then the voice message would be “Lift Number 2 5 Car”.

If the Alarm had been from the Master Controller, then the voice message would be “Lift Number 0 0 Machine Room”.

## No Active Alarm Present

If there is no active alarm, then the Master Controller waits for user action on the remote handset. In this state the Master Controller has its microphone and speaker turned off. The user can perform the following actions.

- **Page a Station** : Enter the following sequence on the keypad of handset to page a Station

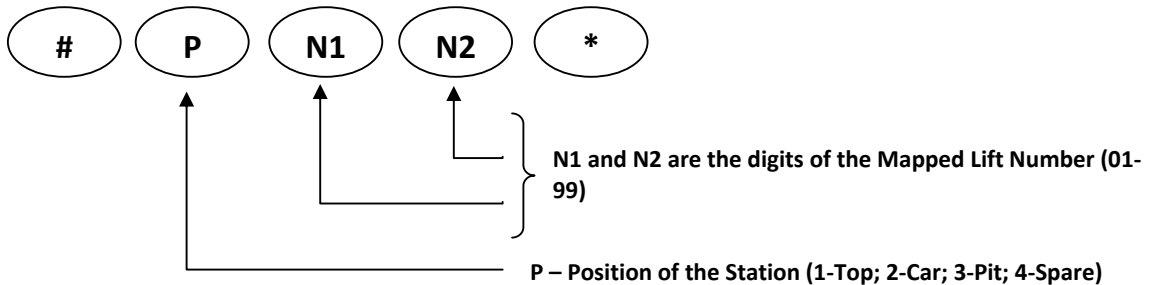

The call will be routed to the respective Station.

- **Hanging-up a paged Station**: The remote handset can hang-up the Station and switch the call back to the initial state in which the Master Controller waits for another user action. Enter the following sequence on the keypad of the handset to hang-up the Station.



- **Speak with the Master Controller**: Enter the following sequence on the keypad of the handset to speak with the Master Controller.



The Master Controller will then turn on its microphone and speaker for speech.

- **Program/Verify the System**: The parameters of the system can be programmed and verified from the handset using the keypad sequences.
- **Record unit identification voice message**: Voice message that identifies the unit can be recorded. Please refer to the ‘Voice Message’ section for detailed information.

## User Operation during a Call After Dialing-In

Listed below are the operations that are possible while in call with a Station or the Master Controller.

- **In call with a Station:**

1. Program/Verify parameters of the System.
2. Hang-up the respective Station by pressing '##', which switches the call back to the Master Controller. The Master Controller will wait for user action as mentioned in the section above. The microphone and speaker on the Master Controller are off in this state. This is very useful if the caller wishes to page any other Station or record voice.
3. Reset any active alarm. Please refer to the section 'Resetting Alarms'.
4. Initiate Reporting.

- **In call with Master Controller:**

1. Program/Verify parameters of the System.
2. Record unit identification voice message.
3. Page a Station.
4. Reset any active alarm. Please refer to the section 'Resetting Alarms'.
5. Initiate Station Self Test.
6. Initiate Reporting.

### Ending a Call

An external call can be ended by simply hanging up or by pressing the following sequence on the remote handset

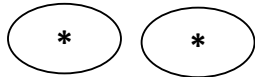

### Security Auto-Answer

The Security Auto-Answer feature is used to dial into the Master Controller when the auto-answer is disabled. Follow the steps given below to temporarily enable auto-answer.

1. Dial into the LX Intercom System and hang up after one ring.
2. After 8 seconds and before 15 seconds dial into the LX Intercom System again.
3. The Master Controller will auto-answer.

## Intercom Calls

The LX Intercom System allows point-to-point and page all communications between units in the network. Following is a representation of intercom calls that are possible.

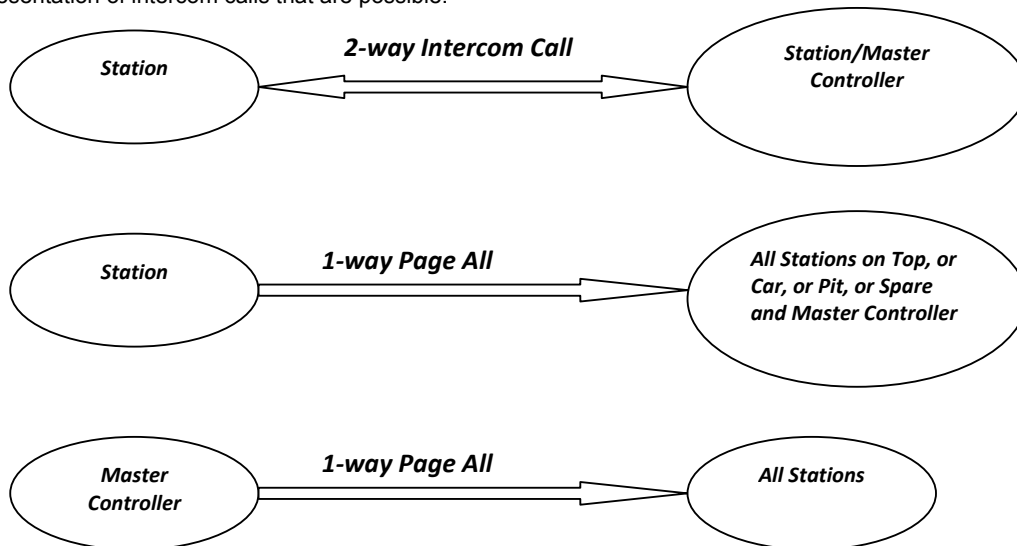

## 2-Way Intercom Calls

Any Station and the Master Controller can page each other and establish a 2-way Intercom Call.

- **Station paging another Station:** Enter the following keypad sequence on the Station keypad to page a Station for a 2-way intercom call.

- **Station SL**

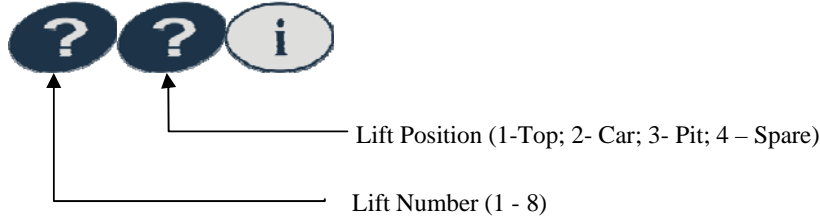

- **Station SK**

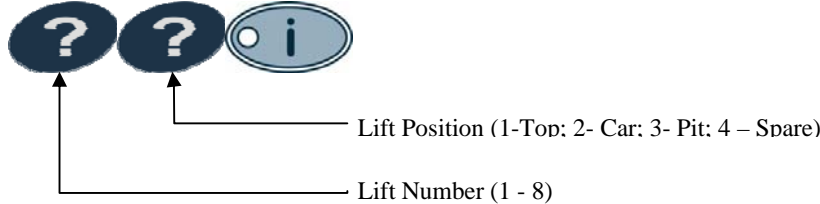

The LEDs on the Stations involved in an intercom call will be steady ON.

The LCD on the Master Controller will show which Stations are engaged in the Intercom Call.

Any other Station trying to page during an ongoing Intercom Call will be kept on hold and the Station will play a busy tone. The waiting Station will be allowed to page as soon as the existing Intercom Call ends.

- **Station paging Master Controller:** Enter the following keypad sequence on the Station to page the Master Controller

- **Station SL**



- **Station SK**



- **Ending an Intercom Call on a Station:** Press the keys shown below to end the Intercom Call

- **Station SL**



- **Station SK**



- **Master Controller paging a Station:** The LX8 Master Controller has LCD Menus to Page a Station.

Following are the steps to page a Station.

1. In the LX-8 Main Menu, enter the 'Call Lift' menu.

2. You will enter the 'Lift Number' menu. Scroll to the desired Lift Number and press the  button.

3. You will enter the 'Lift Position' screen shot. In this screen, all the Stations that are active will have a tick against them and all the Stations that are not active will have a cross against them.

4. Scroll to the desired Station and press the  button to page that Station.

A successful page will take you to the 'Intercom Call' screen shot that indicates the Station being paged.

- **Master Controller ending an Intercom Call:** The Master Controller can end its own Intercom Call or an Intercom Call

on any two Stations by pressing the  button.

## Station 1-Way Page All Calls

The Stations can page all Stations that are located on Top, or in Car, or in Pit, or as Spare as a group. Enter the following keypad sequences to page all in a group from a Station

- **Station SL Paging All**



- **Station SK Paging All**



**Group: 1-Top; 2- Car; 3-Pit; 4-Spare**

The Master Controller is always involved during a page all call.

Since it's a one-way call, the units on the receiving side will have their speakers turned on and their microphones turned off.

- **Ending a Page All:** On the Station that initiated the Page All, press the key shown below to end the call.
  - **Station SL**



- **Station SK**



The Master Controller can end the Page All call by pressing the  key.

## Master Controller 1-Way Page All Call

The LX8 Master Controller has LCD Menus to Page All Stations in a group.

Following are the steps to page a Station.

1. In the LX8 Main Menu, enter the 'Call Lift' menu.
2. You will enter the 'Lift Number' menu.

3. Scroll down to 'All' and press the  button.

4. You will enter the 'Lift Position' screen shot. The Station locations that are available will have a tick against them.

5. Select the desired location and press the  button to page all the Stations in that location.

## Unit Converting a Page All to an Intercom Call

A Station or the Master Controller on the receiving end of a Page All can convert the call into a 2-Way Intercom Call with the unit that initiated the Page All. Press the key shown below

- **Station SL**



**Press the External Alarm Button for the duration of the De-bounce Time**

- **Station SK**



- **Master Controller**



The Master Controller screen will show which Stations are in an Intercom Call after the Page All.

## Master Controller as third-party in an Intercom Call

The LCD on the Master Controller will show the Stations that are in an Intercom Call. The Master Controller can join a call as a third party by following the prompt on the LCD screen.

## LX8 Master Controller User Interface

The user interface on the LX8 Master Controller is provided by means of an LCD, a keypad and an LED. The LCD displays menus for programming and verifying parameters and also gives system state information such as incoming alarm call, incoming external call, intercom with a station, dialling out, reporting, etc. Given below is an image of the LX8 Master Controller.



Note: Image not to scale

Following gives the functionality of the keys.

- Up and Down Arrows – To scroll through the menus and also to increase or decrease speaker volume during a call.
- Digits 0 to 9 – To enter programming parameters.
- ALARM – To raise an alarm and accept an incoming alarm from a Station.
- ENTER – To enter programming parameters and accept incoming alarm from Stations and incoming phone calls.
- END – To end calls or clear entered programming parameters.
- PTT (Green color) – Press to Talk button during a call or when in idle, the call get number

Following gives the LED behaviour

- LED Flashing
  - ON Time > OFF Time – Power supply connected
  - OFF Time > ON Time – Power supply disconnected and unit is running on back-up battery.
  - ON Time = OFF Time and LCD OFF – Unit running Boot loader.

### Checking Unit Status

The current unit status can be checked via an LCD screen shot.

1. In the LX-8 Main Menu, scroll down to '**Check Unit Status**'.
2. The screen shot '**System Status**' shows the following information.
  - a. **Rev** – Current Master Controller firmware version.
  - b. **Ph. Line** – The Status of the phone line. A tick implies phone line is connected and a cross implies phone line is disconnected.
  - c. **A/C Power** – The status of the A/C Power. A tick implies A/C power is connected and a cross implies A/C power is not connected and the unit is running on back-up battery.
  - d. **Active Stations** – All Stations that are currently registered as '**Active**' in the Master Controller.

### Last Active Alarm

The LCD screen on the LX8 Master Controller shows the last Active Alarm at the bottom right corner of the screen. The line says '**ALM-**', and the source is shown next to it. The source could either be the Station or the Master Controller.

## Station SK User Interface

The user interface on Station SK is provided by means of a keypad, beeps from the speaker and an LED. Given below is an image of the Station SK



*Note: Image not to scale*

Following gives the functionality of the keys

- ALARM – Raise an alarm.
- Digits 1-8 – Use to enter programming parameters and also page a Station. '5' and '6' are also used to increase and decrease speaker volume during a call.
- X/END – End a call and to enter and exit programming mode.
- i/Mic – Use along with the digit keys to page stations and receive page all. It is also used as a 'Press to Talk' button during a call.

Following gives the interpretation of the speaker beeps when application is running.

- All key presses produce single beep.
- Upon power-up
  - Speaker beeps 4 times.
- Entering programming mode
  - Speaker beeps 4 times.
- Exiting programming mode
  - Speaker beeps 3 times.
- Successful programming
  - Speaker beeps 2 times.
- Alarm has been raised and waiting for an answer
  - Speaker sounds ringing tone.
- Station paged a busy bus.
  - Speaker sounds a busy tone.

Following gives the interpretation of the speaker beeps when Boot loader is running.

- All key presses produce single beep.
- Upon power-up and when the unit boots into the Boot loader.
  - Speaker sounds a single beep.

Following gives the LED behaviour

- LED steady ON – Unit is in call.
- LED flashing at a fast rate (OFF Time = ON Time) – Unit running Boot loader.
- LED flashing slowly (OFF Time > ON Time) – Unit running Application.



## Station SL User Interface

The user interface on Station SL is provided by means of a keypad, beeps from the speaker and an LED. Given below is an image of the Station SL

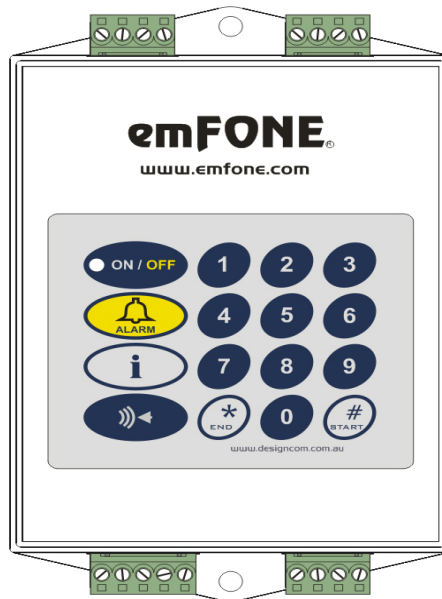

*Note: Image not to scale*

Following gives the functionality of the keys

- ALARM – Raise an alarm.
- Digits 1-8 – Use to enter programming parameters and also page a Station. '5' and '6' are also used to increase and decrease speaker volume during a call. Digits 0 and 9 not used
- ON/OFF – End a call and to enter and exit programming mode.
- i – Used along with the digit keys to page stations and receive page all. .
- PTT – Press to Talk

Following gives the interpretation of the speaker beeps when application is running.

- All key presses produce single beep.
- Upon power-up
  - Speaker beeps 4 times.
- Entering programming mode
  - Speaker beeps 4 times.
- Exiting programming mode
  - Speaker beeps 3 times.
- Successful programming
  - Speaker beeps 2 times.
- Alarm has been raised and waiting for an answer
  - Speaker sounds ringing tone.
- Station paged a busy bus.
  - Speaker sounds a busy tone.

Following gives the interpretation of the speaker beeps when Boot loader is running.

- All key presses produce single beep.
- Upon power-up and when the unit boots into the Boot loader.
  - Speaker sounds a single beep.

Following gives the LED behaviour

- LED steady ON – Unit is in call.

## Press To Talk

The Stations and the Master Controller have press to talk feature that is very useful in noisy environments.

The following keys are used for Press To Talk during conversation.

- **Master Controller -** 

- **Station SL -** 

- **Station SK -** 

Following is a table illustrating the affect of the 'Press To Talk' button

Press To Talk Button	Microphone State	Speaker State
Pressed	ON	OFF
Not Pressed	OFF	ON

**NOTE:** The Press To Talk button on the Master Controller acts as the Dial Get Number button when there is no call active.

## Resetting Alarms

All Alarms that dial-out are registered as Active Alarms. When an Alarm is attended to, it has to be cleared by the rescue service. This implies:

- The rescue service has attended to the Alarm Call and has reset or cleared the Alarm.
- After resetting the alarm, any phone call made to the System will not route to any Units as no Alarms exist. The Master Controller will auto-answer (if enabled) and wait for user action on the remote handset.

The last Active Alarm will be shown at the bottom right corner of the LCD in the LX-8 Main Menu. It will be shown as '**ALM-**' and the source will be shown next to it.

### Resetting Alarms on LX8 Master Controller

The Alarms can be cleared or reset on the LX8 Master Controller using the LCD Menus and via the remote handset.

Follow the steps given below to Reset Alarms.

1. In the LX8 Main Menu, scroll down to the '**Reset Alarm**' menu option and select it.
2. You will be prompted for an Alarm Pin. This is the four digit Alarm Pin.
3. Enter the Alarm Pin. After the Pin is authenticated successfully, the Alarm is reset.
4. A message that says '**Alarm is cleared**' is shown after the Alarm is successfully reset.
5. After the Alarm is reset, the message showing the last Active Alarm in the LX-8 Main Menu will disappear.

If reporting in enabled, then the System will start reporting about the Alarm Reset.

### Resetting Alarms from a Remote Handset

Alarms can be cleared by a remote handset when in call with the LX System. After establishing the call, press the keypad sequence given below on the remote handset keypad.

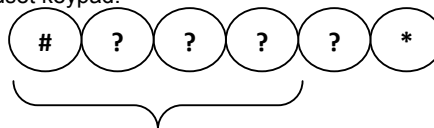

Alarm PIN

# Maintenance

## Firmware Upgrades

Firmware on the Stations and the Master Controller can be upgraded by means of an SD (Secure Digital) Card. Following gives the steps required to upgrade firmware and prepare the SD Card with the right files.

### Preparing SD Card

The files that will be supplied for respective firmware upgrades are as follows

- LX8M.abd – Upgrade file for Master Controller.
- STNK.abd – Upgrade file for Station SK.
- STNL.abd – Upgrade file for Station SL.

The following precautions must be followed when preparing an SD Card with the above files.

- Do not rename the files mentioned above.
- Use only SD Cards of size less than 2 GB.
- Always Format the SD Card in Fat 16 format before transferring the files onto the SD Card. Use the following procedure in Windows XP to format the file in Fat 16
  - Right click on the SD Card drive.
  - Select 'Format...'
  - **In the 'Format' menu select the File System as 'FAT'. This will select the Fat 16 format.**
  - Click on 'Start'.
  - When formatting is finished, click on 'Close'.
  - **NOTE: Do not select 'Quick Format'.**

### Identifying Fat 12 Format SD Cards



Sometimes, SD Cards that are of low capacity such as 16MB SD Cards are formatted in Fat 12 format when you select 'FAT' in the 'Format' menu of Windows. This is because of the nature of those SD Cards.

**Please note that SD Cards that have Fat 12 format cannot be used.**

The following steps will help in identifying SD Cards that have Fat 12 format.

- Right click on the SD Card drive.
- Click 'Properties'.
- Click 'Tools'.
- Click 'Defragment Now...'
- In the 'Disk Defragmenter' window, select the SD Card drive and click on 'Analyze'
- If the SD Card is in Fat 12 Format, then a window will pop up. It says "Volume (X:) has a 12 bit FAT partition."
- If the SD Card is in Fat 16 format, then the Disk Analyze will proceed to analyze the disk.

### Upgrading Firmware on Stations on LX-8

1. Scan the bus for all Active Stations.
  2. Ensure that all connected Stations are shown as Active.
  3. In the LX-8 Main Menu, enter the menu '**Configure System**'. When you do so, you will be prompted for a pin.
  4. Enter the Programming Pin. If it is successful, you will enter the '**Program Settings**' Menu.
  5. Scroll down to '**Upgrade Firmware**' menu option and select it.
  6. You will enter the '**Upgrade Firmware**' menu.
  7. Now, select '**Stations – Top, Pit, Spare**' to upgrade Stations SK or '**Stations-Car**' to upgrade Stations SL.
  8. After selecting the option mentioned above, you will be prompted to insert the SD Card.
  9. Now, insert the SD Card.
  10. If there is no error, the LCD will show '**Please Wait...**'. If there is an error in the SD Card, the LCD will show '**SD Card Error**' and the Master Controller will go back to the main menu.
  11. The screen shot '**Please Wait...**' will be shown for the duration of the upgrade. The progress of the upgrade will be shown by means of stars (\*), one star appearing for each Station getting upgraded.
  12. Please do not remove the SD Card at this stage.
  13. After the upgrade is finished, the LCD will show the status. Depending on the status of the upgrade, the LCD will either show all Active Stations or the Stations that have not responded.
  14. All Stations that failed an upgrade will be shown as '**Stations Not Responding**' in '**System Status**' screen shot that appears after the upgrade
  15. If all the Stations involved in the upgrade upgraded successfully, then '**Active Stations**' will be shown in '**System Status**' screen shot that appears after the upgrade. Please note that all Active Stations will be shown regardless of whether it was a Station SK upgrade or a Station SL upgrade.
- 
16. Press the  button to exit display of the System Status.
  17. **NOTE: After the upgrade, please ensure that each of the Active Stations can be paged to ensure that all Stations have been upgraded and are online.**

## If an upgrade fails

The Flashing LED will indicate which Station failed an upgrade. The following steps must be taken.

1. If a Station fails an upgrade, it will be taken off line by the Master Controller.
2. Check the Station that failed the upgrade for any connectivity issues.
3. The failed Station should be brought back online so that a scan of the bus will show it. Turning the power off and on again will bring online all those Stations that have been taken offline due to a failed upgrade.
4. Repeat the firmware upgrade of the Stations as described in the previous section.
5. This time, all the Stations that have been upgraded successfully in the first attempt will be bypassed. You will notice that the stars(\*) in the '**Please Wait...**' screen shot will start appearing at a faster rate (approximately 10 seconds) for all those Stations that have been upgraded successfully in the first attempt.

## Upgrading Firmware on LX8 Master Controller

1. In the LX-8 Main Menu, enter the menu '**Configure System**'. When you do so, you will be prompted for a pin.
2. Enter the Programming Pin. If it is successful, you will enter the '**Program Settings**' Menu.
3. Scroll down to '**Upgrade Firmware**' menu option and select it.
4. You will enter the '**Upgrade Firmware**' menu.
5. Now, select '**Master Controller**' to upgrade the Master Controller.
6. After selecting the option mentioned above, you will be prompted to insert the SD Card.
7. Now, insert the SD Card.
8. The Master Controller will reboot in the Boot loader. The LCD will go blank. Please do not remove the SD Card at this stage because the Master Controller is actually upgrading the firmware from the SD Card. You will also see the heart beat LED flashing at approximately half a second.
9. The Master Controller will boot with the new application in less than 20 seconds.

## System Indications

The LX8 Master Controller will indicate several things during an upgrade process.

- **After inserting an SD Card for a Master Controller firmware upgrade, the Master Controller goes back to its idle state and does not initiate an upgrade.**  
This means that the version number of the firmware on the SD Card is the same as the version number of the firmware being currently run.
- **The LCD shows 'SD Card Error' on the Master Controller after inserting an SD Card for a firmware upgrade.**  
This means that the SD Card is faulty or does not contain the file for the respective upgrade. When this happens, format the SD Card using the method mentioned above and transfer the file(s) again.

## Station Car Self Test

The LX Intercom System has the ability to initiate a self test on all Station Cars. When initiated, the Station Cars perform a self test of their microphone-speaker circuitry and also the alarm button connectivity.

The test is initiated every 24 hours or when initiated manually from the LX8 Master Controller or from a remote handset.

### Initiating Station Self Test Manually on LX8 Master Controller

Use the following steps to initiate a Station Self-Test from the LX8 Master Controller keypad interface.

1. In the LX8 Main Menu, scroll down to the menu option '**Start Station Self Test**' and select it to initiate a Station Self Test.
2. The LCD screen will show '**Please Wait...**' during the duration of the self test.
3. The result of the self-test will be shown in the '**System Status**' screen after the test.
4. The section '**Self Test Status**' will show the status of the self-test on all Active Station Cars. There are two columns in the '**Self Test Status**'- '**VT**' and '**ABT**'. VT stands for Voice Test and ABT stands for Alarm Button Test.
5. A tick against VT or ABT implies that the Voice Test or the Alarm Button Connectivity Test on that Station has passed. A cross implies a failure.
6. Press  to exit this status display.

## **Initiating Station Self Test from a Remote Handset**

Use the following steps to initiate a Station Self-Test from a remote handset

1. Dial into the LX Intercom System.
2. Make sure that there are no Active Alarms in the System. If there are, reset the Alarm (Please refer to the section 'Resetting Alarms'), hang-up and dial again.
3. When dialed into, the Master Controller will auto-answer (if enabled).
4. Enter the keypad sequence shown below on the keypad of the remote handset.
5. Enter the keypad sequence to initiate the self-test.

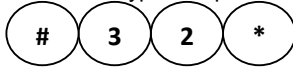

6. Wait for a few seconds as the Stations perform their self-test.
7. Voice messages will be played indicating status of the tests.

## **Remote Handset Programming Keypad Commands**

Remote Handset Programming Keypad Commands		
Help Number Programming		
Parameter	Programming Sequence	Verification Sequence
Help Number 1	# [Programming PIN] # 0 (16 digits) *	*0
Help Number 2	# [Programming PIN] #1(16 digits)*	*1
Help Number 3	# [Programming PIN] #2(16 digits)*	*2
Help Number 4	# [Programming PIN] 1#0(16 digits)*	*#10
Help Number 5	# [Programming PIN] 1#1(16 digits)*	*#11
Help Number 6	# [Programming PIN] 1#2(16 digits)*	*#12
Help Number 7	# [Programming PIN] 2#0(16 digits)*	*#20
Help Number 8	# [Programming PIN] 2#1(16 digits)*	*#21
Help Number 9	# [Programming PIN] 2#2(16 digits)*	*#22
All Help Numbers	# [Programming PIN] 9#0(16 digits)*	-NA-

Remote Handset Programming Keypad Commands		
Maintenance Number Programming		
Parameter	Programming Sequence	Verification Sequence
Maintenance Number 1	# [Programming PIN] 3#0(16 digits)*	*#30
Maintenance Number 2	# [Programming PIN] 3#1(16 digits)*	*#31
Maintenance Number 3	# [Programming PIN] 3#2(16 digits)*	*#32
Get Number Programming		
Parameter	Programming Sequence	Verification Sequence
Get Number	# [Programming PIN]#4(16 digits)*	*4



Telephone Options		
Parameter	Programming Sequence	Verification Sequence
Telephone Options	# [Programming PIN] #5ABCDEFGH*  A-Dial Time (1-9) x 5 seconds (normal) x 10 seconds (switch) B-Talk Time (1-9) x 2 minutes C-Silence Time (1-9) x 5 seconds D-Alarm Button Timer (1-9) seconds E-Auto Answer Ring Count (1-9) x 2 F-Auto-Answer Enable(0=Disabled,1=Enabled) G-Ringer Control (0=Disabled,1=Enabled) H-PABX Continuous Tone Detect Enable (0=Disabled,1=Enabled)	*5
New Programming PIN		
Parameter	Programming Sequence	Verification Sequence
New Programming PIN	# [Programming PIN] #3ABC* {A,B,C} – New PIN	*3
Master Controller Ring Time And Voice Record		
Parameter	Programming Sequence	Verification Sequence
Master Controller Ring Time	# [Programming PIN] #6AB*, {A,B} – Two digits ranging from 00 to 99 seconds	*6
Voice Record	# [Programming PIN] #9 Start recording after the voice message “Sequence Accepted”. Press ‘0’ to finish recording.	*9
Transmit / Receive Gains And Busy Tone Cadence		
Parameter	Programming Sequence	Verification Sequence
Transmit/Receive Gain And Busy Tone Cadence	# [Programming PIN] #8AB* A- DTMF Transmit Adjustment (0(min)-9 (max)) B- Busy Tone Cadence (0,1) 0=210ms to 750ms; 1=60ms to 750ms	*8



## Remote Handset Programming Keypad Commands

### Reporting

Parameter	Programming Sequence	Verification Sequence
Reporting Enable	# [Programming PIN] 9#7A* A=0 Disable A=1 Enable	*#7
Reporting Telephone Number	# [Programming PIN] 9#4(16 digits)*	*#4
Reporting Frequency	# [Programming PIN] 2#7AB*, {A,B} – Two digits ranging from 01 to 30 days	*#5

### Digital Voice And Relay

Parameter	Programming Sequence	Verification Sequence
Digital Voice And Relay	# [Programming PIN] #7ABC* A: Digital voice message: <ul style="list-style-type: none"> <li>• 0: Disabled</li> <li>• 1: Played upon answer of emergency call</li> <li>• 2: Played only when requested</li> <li>• 3: All non-programming voices disabled.</li> <li>• 4: Every 1 Minute</li> </ul> B: Relay options: <ul style="list-style-type: none"> <li>• 0: Disabled</li> <li>• 1: Line on</li> <li>• 2: Any fault</li> <li>• 3: Call answered</li> <li>• 4: Code sent</li> <li>• 5: EMU</li> </ul> C: Relay ON time (1-9) x 2 s	*7

### New Alarm PIN Programming

Parameter	Programming Sequence	Verification Sequence
Alarm PIN Number 1	# [Programming PIN] 9#51ABCD* {A,B,C,D} – New PIN	*#51
Alarm PIN Number 2	# [Programming PIN] 9#52ABCD* {A,B,C,D} – New PIN	*#52
Alarm PIN Number 3	# [Programming PIN] 9#53ABCD* {A,B,C,D} – New PIN	*#53
Alarm PIN Number 4	# [Programming PIN] 9#54ABCD* {A,B,C,D} – New PIN	*#54
Alarm PIN Number 5	# [Programming PIN] 9#55ABCD* {A,B,C,D} – New PIN	*#55
Alarm PIN Number 6	# [Programming PIN] 9#56ABCD* {A,B,C,D} – New PIN	*#56
Alarm PIN Number 7	# [Programming PIN] 9#57ABCD* {A,B,C,D} – New PIN	*#57
Alarm PIN Number 8	# [Programming PIN] 9#58ABCD* {A,B,C,D} – New PIN	*#58

### Master Controller Data Bus Voltage Reference

Parameter	Programming Sequence	Verification Sequence
Master Controller Data Bus Voltage Reference	# [Programming PIN] 7#9N* N Ranges from 1 to 5 N=1 =>1V N=2=>1.5V N=3=>2V N=4=>2.5V N=5=>3V	*#79



## Remote Handset Function Keypad Commands

Remote Handset Function Keypad Commands	
Alarm Log Reset Initiate Station Self Test Initiate Manual Report Hang up Station Paging Station From Remote Handset	
Parameter	Keypad Sequence
Alarm Log Reset	# [4 Digit Alarm PIN]*
Initiate Station Self Test	#32*
Initiate Manual Report	#00*
Hang up Station	## Call is routed back to Master Controller and Master Controller waits for user action
Paging Station from Remote Handset	# P N1 N2 * P-Position of Station (1-Top; 2-Car; 3-Pit; 4-Spare) {N1,N2}-Mapped Lift Number (01-99)
Firmware Version	#01*
End Call	**
Lift Number Mapping Verification	
Parameter	Keypad Sequence
Lift 1	##61
Lift 2	##62
Lift 3	##63
Lift 4	##64
Lift 5	##65
Lift 6	##66
Lift 7	##67
Lift 8	##68





# LX8M Master Controller Dimensions

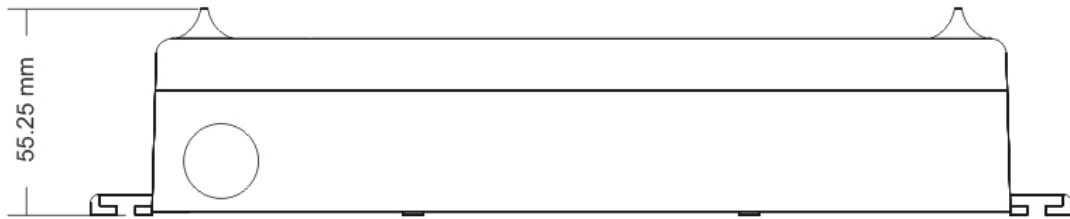
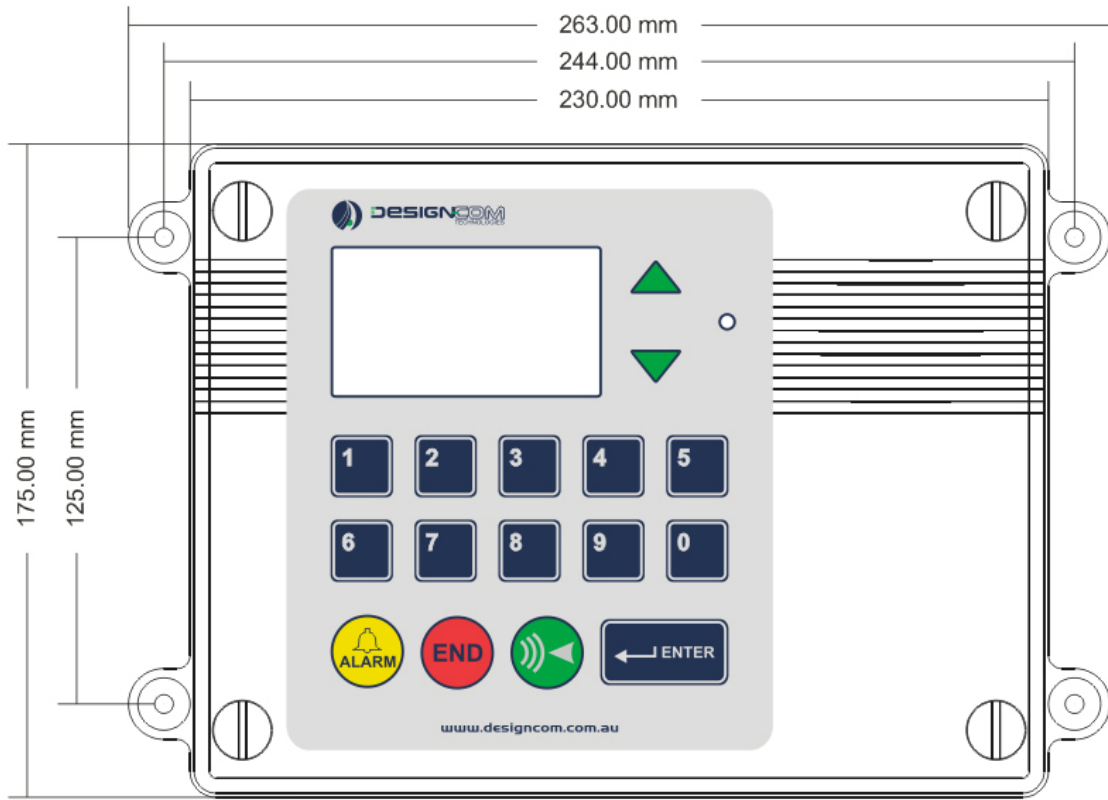

# LX Intercom System Electrical Specifications

## ***Master Controller Specifications***

<b>Operating Voltage</b>	240V AC 50Hz / 60Hz – AC Adaptor supplied 18VDC 3Amp
<b>Operating Current</b>	155 mA (Standby) 170 mA (Operating)
<b>Operating Temperature</b>	0°C - 75°C
<b>Telephone Line Voltage</b>	24V – 50V DC
<b>Telephone Line Current</b>	10mA – 90mA
<b>Dialing Method</b>	Tone (DTMF)
<b>Backup Battery System</b>	Lead Acid – minimum operating life 3 years
<b>Digital Voice Messages</b>	20 year retention and 100,000 record cycles minimum
<b>Recorded Message Length</b>	16 seconds
<b>Require BUS Cable</b>	24 AWG twisted shield pair (2 single twisted, shielded cable)

## ***Station Specifications***

<b>Operating Voltage</b>	16V DC Supplied by Master Controller
<b>Operating Current</b>	Station SK : 35 mA (Standby); 60 mA (Operating) Station SL : 25 mA (Standby); 55 mA (Operating)
<b>Operating Temperature</b>	0°C - 75°C
<b>Relay Contacts</b>	NO/NC selectable – 1A / 24V DC
<b>Data</b>	Peer to Peer Single Wire
<b>Signal</b>	600 $\Omega$ impedance
<b>Speaker Level</b>	Greater than 80dB
<b>Microphone</b>	Sensitivity greater than 3-4 meters
<b>Alarm Input</b>	Dry Contact

# LX-TE Wiring Diagram

The LX-TE is used for wiring distribution to the Stations in the LX Intercom System.

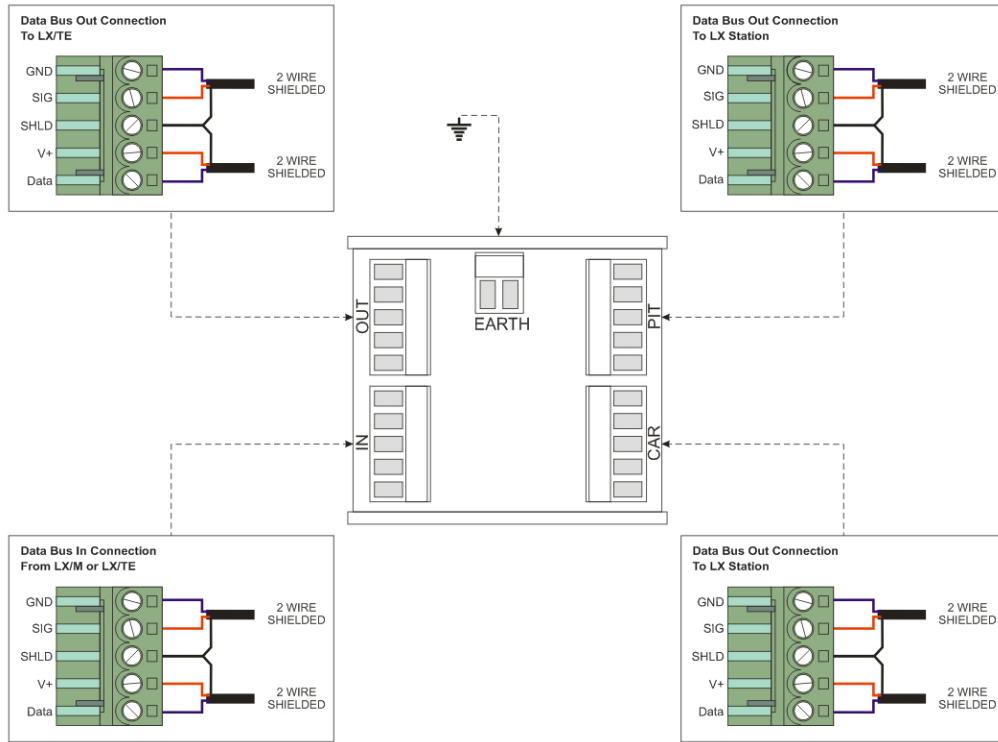

## LX-TE Dimensions

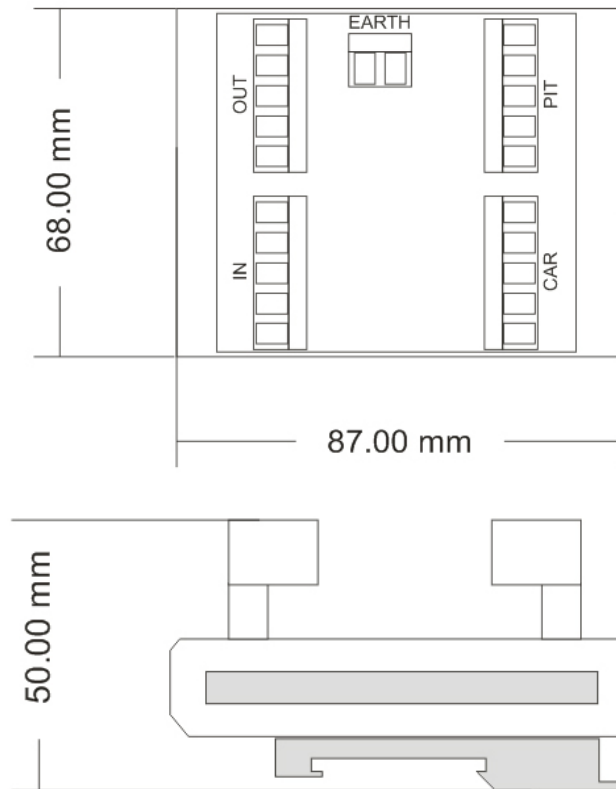

# Station Programming Keypad Commands

The Station must be put into Programming Mode before using the keypad command given below. Follow the steps given below to enter/exit programming mode.

- **Station SK**

1. Put the Station into Programming Mode by pressing and holding the  button for three seconds.
2. The Station enters Programming Mode by giving 4 beeps.
3. Enter the desired programming keypad sequence given below.
4. The Station will sound 2 beeps after successful programming.

5. Exit the Programming Mode by pressing and holding the  button for three seconds. The Station will sound 3 beeps when it exits Programming Mode.
6. If the Station is not made to exit Programming Mode manually, it will automatically exit after 7 seconds. It will sound 3 beeps when it exits Programming Mode.

- **Station SL**

1. Put the Station into Programming Mode by pressing and holding the  button for three seconds.
2. The Station enters Programming Mode by giving 4 beeps.
3. Enter the desired programming keypad sequence given below.
4. The Station will sound 2 beeps after successful programming.

5. Exit the Programming Mode by pressing and holding the  button for three seconds. The Station will sound 3 beeps when it exits Programming Mode.
6. If the Station is not made to exit Programming Mode manually, it will automatically exit after 7 seconds. It will sound 3 beeps when it exits Programming Mode.

Station Programming Keypad Commands	
Station Location	
Alarm Debounce Time (Station SL Only)	
Microphone Level Setting	
Speaker Level	
Parameter	Keypad Sequence
Station Location	7851ABE A-Lift Number; Range (1 to 8) B-Station Position; Top – 1; Car – 2; Pit – 3; Spare – 4 <i>Please see Note below</i>
Alarm Debounce Time (Station SL Only)	7852NE N-Range is (1-9) seconds <i>Please see Note below</i>
Microphone Level	7853NE N-Range is (1 (min) – 4 (max)) <i>Please see Note below</i>
Speaker Level	7854NE N-Range is (1(min)-8(max)) <i>Please see Note below</i>

Note: E in the table is  button in Station SK and is  button in Station SL

## Station Programming Keypad Commands

Data Load Set Data Load Clear Data Bus Voltage Reference Scream Settings (Station SL Only)	
Parameter	Keypad Sequence
Data Load Set	7856E <i>Please see Note below</i>
Data Load Clear	7855E <i>Please see Note below</i>
Data Bus Voltage Reference	7857NE N=1 =>1V N=2=>1.5V N=3=>2V N=4=>2.5V N=5=>3V <i>Please see Note below</i>
Scream Settings	7858ABN A – Scream amplitude threshold; Range (1(min)-8(max)) B – Scream sample time; Range (1(min)-8(max)) If either setting is 0, scream detection will be disabled. <i>Please see Note below</i>

Note: E in the table is  button in Station SK and is  button in Station SL

## Station SK Unit Dimensions

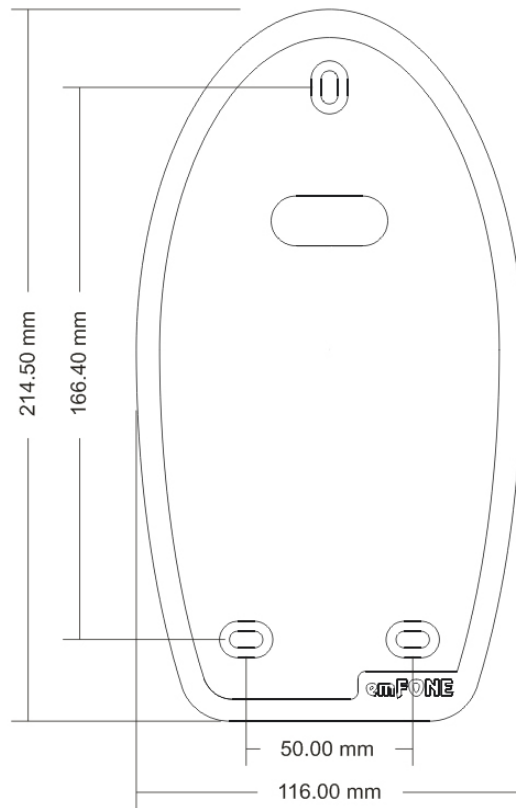

## Station SK Wiring Diagram

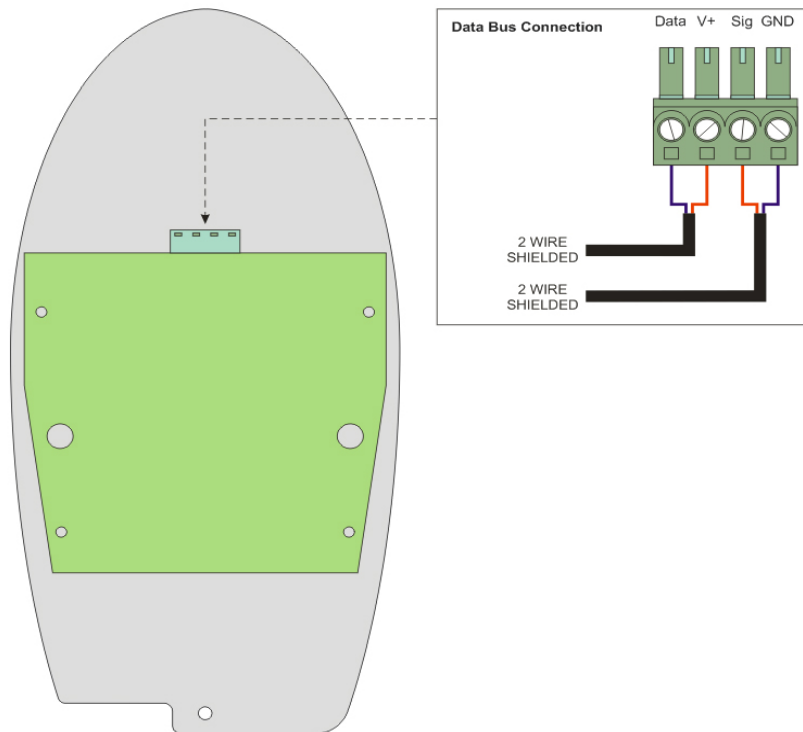

# Station SL Unit Dimensions

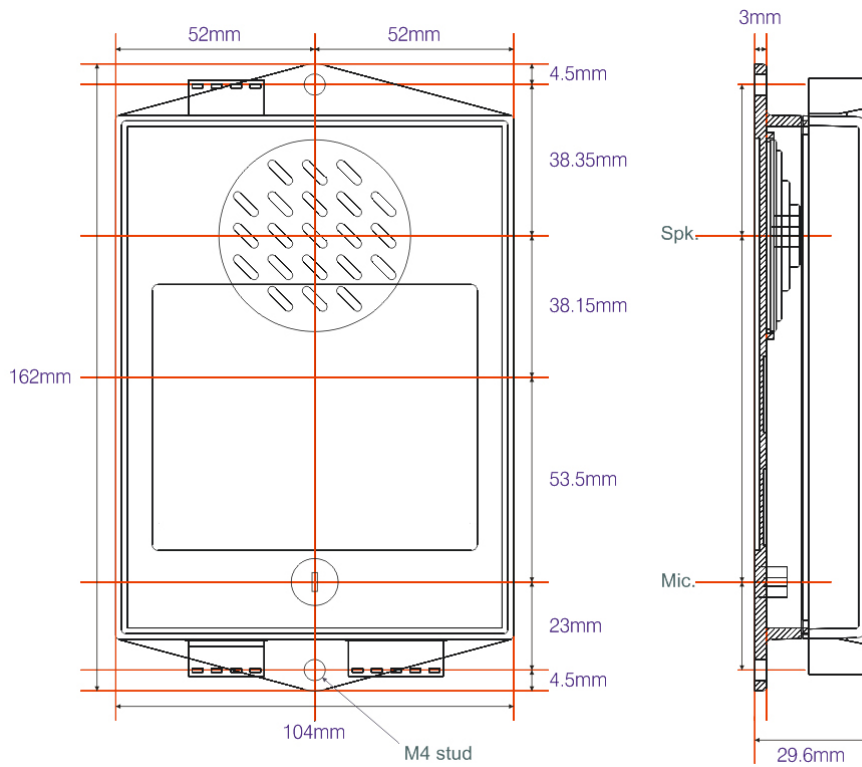

# Station SL Wiring Diagram

